

# schaerer<sup>®</sup> axis

200/300 series

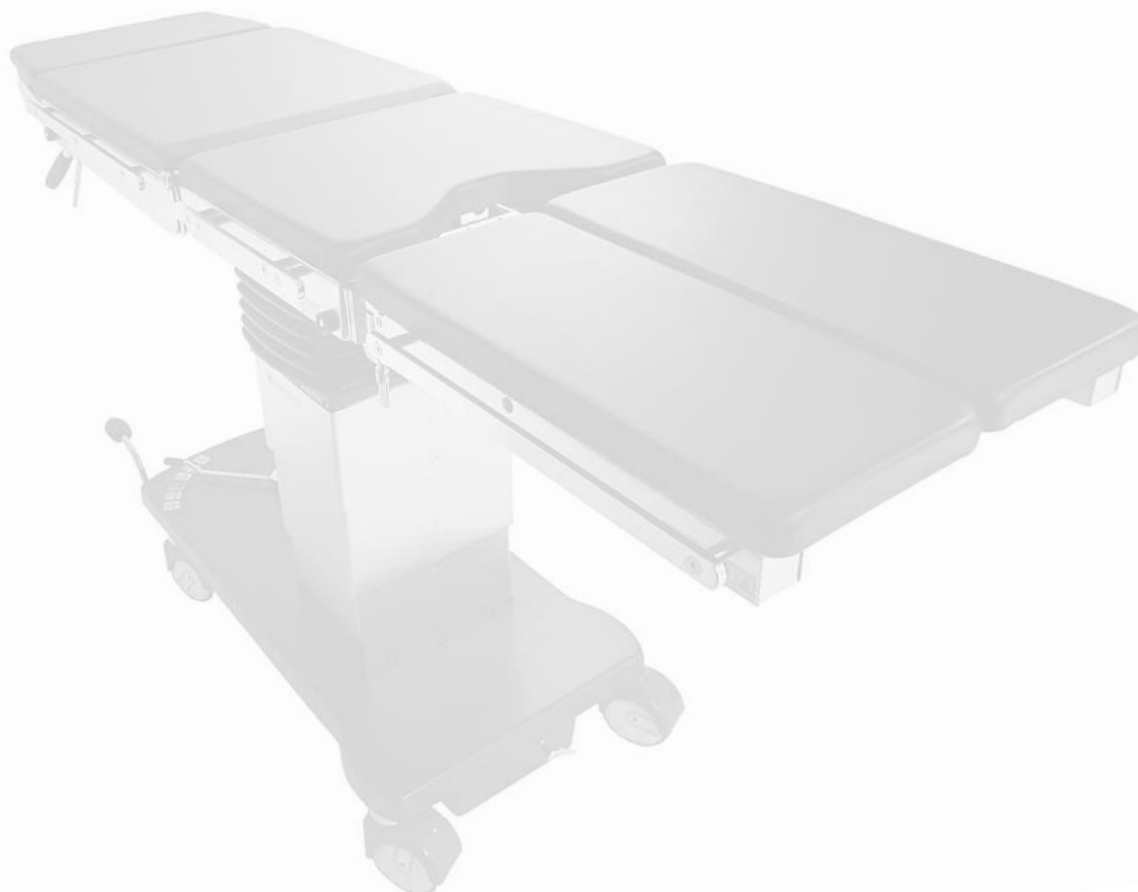

MOBILE OPERATING TABLES  
FOR ALL SURGICAL APPLICATIONS



Exclusive Philippine Distributor:

**WellnessPRO**  
tomorrow's medical devices

Unit 808 Richmond Plaza, San Miguel Ave cor Lourdes St.,  
Ortigas Ctr. Pasig City 1605 Philippines  
Mobile no.: +63 922 896 0964  
Tel. no.: +63 2 636 3580, +63 2 637 0930, +63 2 637 0473  
Fax: +63 2 636 7542  
Email: [wellnessproinc@gmail.com](mailto:wellnessproinc@gmail.com), [jcjuan@wellnessproinc.com](mailto:jcjuan@wellnessproinc.com)  
[www.wellnessproinc.com](http://www.wellnessproinc.com)

 **schaerermedical<sup>®</sup>**

**schaerer® axis 200/300 series**  
**Mobile operating tables for all surgical disciplines**

The product line schaeerer® axis 200/300 series sets the introducing standard for professional and safe clinical and outpatient care giving for all surgical disciplines.

Starting with the manually operated **schaerer® axis 200** to the electrohydraulic **schaerer® axis 303E Top-level system** - choose out of 10 different configurations for your individual requirements.

All models are manually operated by hydraulics and gaspring supports. The „E“ series offer an additional batterie driven electrohydraulic system to move the column and the Top Level (Trendelenburg/Reverse and lateral tilting).

In addition the schaeerer® axis 302 (E) and schaeerer® axis 303 (E) allow a 250mm Topslide to open the X-Ray window another 250mm.

A wide range of accessories for all patient positioning requirements complete the product line to fulfil all your needs.



**580011 Leg Plate**  
 Split leg plates (pair), lateral swivelling, stepless adjustment of inclination with gas spring.



**580010 Leg Plate**  
 One piece, stepless adjustment of inclination with gas spring.



All models can be optionally equipped with the depicted head and leg plates.



**580008 Head Plate**  
 Stepless adjustment of inclination with gas spring.



**580009 Head rest**  
 With double articulated joint (hinged), ideal for lateral patient positioning, stepless adjustment of inclination with gas spring.

**schaerer® axis models 302, 303, 302E and 303E** are equipped with manual longitudinal shifting (250mm) for unobstructed C-arm positioning.



**schaerer® axis models 201, 301, 303, 301E, 303E** are equipped with an integrated kidney elevator which can be selected with the pre-selection lever and raised via a foot pedal.



Foot pedal (1) for manual adjustment of the table positions. Lever (2) for table locking, directional locking and free wheel position. Position preselection lever (3).



Pre-selection lever for the activation of the integrated kidney elevator (1), raised with the foot pedal (2).



Operating lever with safety position for the gasspring assisted adjustment of the back plate (1). Operating lever with safety position for the manual longitudinal shifting of the table top (2). (When applicable)



All schaeerer axis E models are equipped with a handcontrol to activate the selected function which is electro hydraulically powered.



Low action moving double wheels (additional 5th wheel – “300” series) allow an easy movement by one person in all directions.



**Shoulder surgery**  
with Shoulder-Arthroscopy plate 580174, head rest 580157/580158 and adaptor 580159/580160. Shoulder plate with adjustable side segments for exposure of and optimal access to the shoulder. Inclination adjustment via gas spring.



**General Surgery**  
Cholecystectomy positioning with integrated kidney elevator (schaerer® axis Models 201, 301, 301E, 303, 303E)



**Gynaecology / Urology**  
Gynaecological and urological positions with Infini-Max leg holders 90507 (1) or Goepel leg holders 580086 (2). Seat plate extensions for maximum C-arm access and a variety of basins are available for urological operations.



Positioning for kidney operations



Hand surgery with hand surgery plate 580042



Positioning for rectal surgery

**Technical data**

Length	1140 mm (without head- and leg plates)	2130 mm (with head- and leg-plates)
Width of the table top	540 mm (without side rails)	590 mm (with side rails)
Diameter of the swivelling double castors	125 mm	
Height adjustment range incl. cushions	720–1080 mm (Models without longitudinal shifting)	740–1100 mm (Models with longitudinal shifting)
Trendelenburg / Reverse Trendelenburg	30°	
Back plate adjustment	+70° / -50°	
Leg plate adjustment	+20° / 90°	
Lateral tilting right/left	20°	
Spread of split leg plates	90°	
Head plate adjustment	+20° / -45°	
Angle of head plate with double articulated joint (hinged)	25°	
Manual longitudinal shifting (Models 302, 303, 302E, 303E)	250 mm	
Maximum patient weight (rated load)	135 kg	
Maximum patient weight in horizontal position (without adjustment)	185 kg	
Power supply E-Models	230 V, 50 Hz (other voltages possible)	

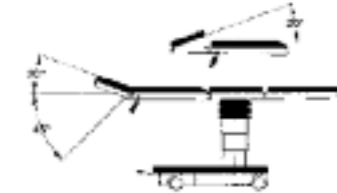
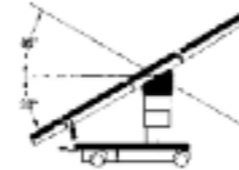
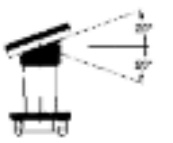
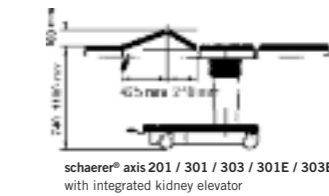
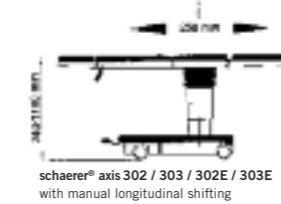
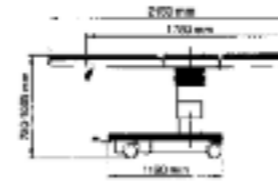

schaerer® axis Models	200	201	300	301	302	303	300E	301E	302E	303E
Article number without head and leg plates	580000	580100	580001	580101	580003	580103	580002	580102	580004	580104
<b>Model-Configuration</b>										
Height adjustment up / down with foot pedal	■	■	■	■	■	■	■	■	■	■
Height adjustment up / down, also electro-hydraulic	-	-	-	-	-	-	■	■	■	■
Trendelenburg/Reverse Trendelenburg with foot pedal	■	■	■	■	■	■	■	■	■	■
Trendelenburg/Reverse Trendelenburg, also electro-hydraulic	-	-	-	-	-	-	■	■	■	■
Lateral tilt l/r with foot pedal	-	-	■	■	■	■	■	■	■	■
Lateral tilt l/r, also electro-hydraulic	-	-	-	-	-	-	■	■	■	■
Manual head plate adjustment with gas spring support	■	■	■	■	■	■	■	■	■	■
Manual back plate adjustment with gas spring support	■	■	■	■	■	■	■	■	■	■
Manual leg plate adjustment with gas spring support	■	■	■	■	■	■	■	■	■	■
Integrated kidney elevator, adjustable via foot pedal	-	■	-	■	-	■	-	-	-	■
Manual longitudinal shifting, 250 mm	-	-	-	-	■	■	-	-	-	■
Fifth wheel for precise directional stability	-	-	■	■	■	■	■	■	■	■
Weight, including head and leg plates	160 kg	170 kg	180 kg	190 kg	190 kg	200 kg	200 kg	210 kg	210 kg	220 kg





**580041 Rapid setting clamp**  
rotating, for bars diameter 16–18 mm  
for side rails 25 x 10 mm



**580020 Rapid setting clamp**  
not rotating, for square bars 20x20mm,  
for side rails 25x10 mm



**580017 Setting Clamp**  
rotating, for bars diameter 16–18 mm,  
for side rails 25x10 mm



**580014 Setting clamp**  
not rotating, for bars diameter  
16–18 mm and for rectangular bars  
10x25 mm, for side rails 25x10 mm



**580156 Knee positioning device**  
**580017 Setting clamp**



**580058 X-ray cassette frame**  
for x-ray cassettes up to 350x430 mm,  
insertable telescoping handle with posi-  
tion marks



**580042 Hand surgery plate**  
X-ray translucent plastic plate with  
telescopic support. Receptacle for  
X-ray cassettes. Dimensions:  
Length 700 mm, width 300 mm.  
**580061 Pad**



**580037 Rectoscopy roll pad**  
for rectoscopy in prone position, swivel-  
ling, height adjustable. Rectoscopy roll  
pad adjustable for different operating  
table widths. Fixed to side rails, without  
clamp.  
**580041 Rapid setting clamps**  
(order 2 pieces) or  
**90506 Rapid setting clamps** for side rails  
25x10 mm or 30x10 mm (order 2 pieces)



**580040 Arm rest**  
Clamp with fixing screw, adjustable  
up/down and laterally, height adjustable,  
swivelling through 180°, length 600 mm,  
width 150 mm  
**580013 Fixing strap**  
(order 1 piece)



**580043 Hand strap**  
with clamp for fixing to the side rail,  
woven fabric strap with velcro fastener,  
washable.

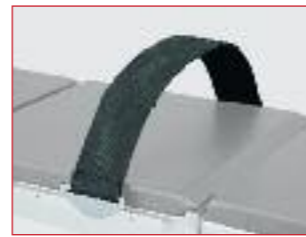

**580045 Body strap**  
with clamps for fixing to the side rail,  
woven fabric strap with velcro fastener,  
washable



**580046 Infusion pole**  
for fixing to the side rail. Extendable. Ball  
and socket joint adjustment. Top part with  
4 hooks.



**580038 Knee cradle/foot plate**  
for fixing to the side rails of the leg plate,  
without fixing clamps.  
**580014 Setting clamps** (order 2 pieces).  
Knee cradle equipped with side rails for  
fixing the rectoscopy-, resp., buttocks roll  
pad 580037 with 2 radial setting clamps  
90506

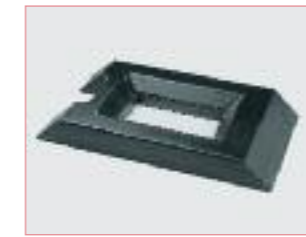

**580056 Dorsal pad**  
for vertebral disc operations,  
840x460x100 mm, abdominal cut-out  
460x300 mm, with cut-out for head



**580161 Wrist hand support**  
suitable for horseshoe-shaped head rests  
**580157 Horseshoe shaped head rest**  
one piece with pad  
**580160 Head plate adaptor**  
with 3 joints



**580158 Horseshoe shaped head rest**  
two pieces with pad  
**580159 Head plate adaptor**  
without joints



**580169 Anesthesia screen**  
**580017 Setting clamp**  
**580168 Extendable roads**  
for anesthesia screen



**580031 Holder for side rest and  
back rest**  
without clamp, height adjustable,  
swivelling with longitudinal extension.  
For receiving the lateral- and back rests  
580032 / 580034 / 580033.  
**580020 Rapid setting clamp**  
(order 1 piece)



**580032 Lateral support**  
for 580031, pad rounded, rotating,  
lockable, detachable. Dimensions pad  
220 x 100 mm



**580034 Back- and buttocks support**  
for 580031, pad rotating, lockable,  
detachable. Dimensions pad  
200 x 120 mm



**580174 Shoulder arthroscopy plate w/o**  
U-shaped head support and head plate  
adaptors  
**580163 U-shapes head support**  
**580160** or **580159 Head plate adaptor**



**580151 Humerus counter traction post**  
**580017 Setting clamp**



**580150 Humerus positioning traction  
device w/o Weinberger hand traction  
device**  
**580017 Setting clamp**



**580152 Weinberger hand traction device**



**580033 Pubis-/sacrum-/sternum  
support**  
for 580031, pad rotating, lockable.  
Dimensions pad 85x85 mm



**580044 Hand strap**  
for hooking onto the anaesthesia  
screen 580169. Woven fabric strap,  
washable, with velcro fastener



**580035 Side rest**  
for fixing to the side rail, pad rounded



**580036 Shoulder rests**  
(Pair), laterally adjustable, height  
adjustable, without clamps,  
with 2 pads.  
**580020 Rapid setting clamps**  
(order 2 pieces)



**580086 Leg rest according to Goepel**  
(Piece) leg cradle with ball and socket  
joint, adjustable.  
**580041 Rapid setting clamp**, rotating  
(order 1 piece)

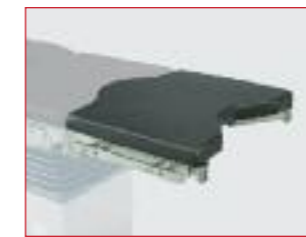

**580080 Urology Adapter**  
For extension of seat plate to ca.  
420 mm, with cutout for urological opera-  
tions. Fully radiolucent. With side rails  
25x10 mm, of nickel chromium steel.  
**580081 Gynaecology Adapter (without  
illustration)**  
For extension of seat plate to ca.  
250 mm in urological and gynaecological  
operations. Fully radiolucent. With side  
rails and gynaecological cutout.



**580077 Pivoting Basin with Rack**  
Basin and rack of nickel chromium steel,  
incl. setting clamp 580017, for attach-  
ment to side rails.  
**580078 Screen Insert**  
Made of nickel chromium steel for  
pivoting Basin 580077



**580164 Universal adaptor**  
suitable for head plate adaptors and  
Doro® ultra base unit

**Schaerer Medical AG**

Erlenauweg 17

CH-3110 Münsingen

Tel. +41 31 720 22 00

Fax +41 31 720 22 30

[info@schaerermedical.ch](mailto:info@schaerermedical.ch)

[www.schaerermedical.ch](http://www.schaerermedical.ch)