

Automatic Blood Pressure Monitor TM-2655/TM-2655P (with printer)

The Ultimate in Ergonomics to Assure Accuracy

The TM-2655 Series is our newest, fully automatic blood pressure monitor with a unique, new ergonomic design. Our ergonomic design provides three advantages over similar models. First, the ergonomic design allows the patient to choose which arm to use, and sit comfortably and with the correct posture. No more stretching and twisting into a knot to try to get comfortable! Second, improved posture and comfort results in greater accuracy. Third, the extremely small footprint fits almost anywhere, in any location. The TM-2655 Series is the answer to the patient's need for comfort and accuracy and everyone's need for floor space.



Clinically
Validated

IHB

CE 0123

Exclusively Distributed by:

WellnessPRO
tomorrow's medical devices

The Ultimate in Ergonomics to Assure Accuracy

The new TM-2655 Series of fully automatic blood pressure monitors ensures proper measurement through proper positioning. Unlike other commercial blood pressure monitors, the TM-2655 allows the patient more flexibility in positioning when taking a measurement. Because its unique design places the cuff on top of the machine, patients can use either the left or right arm for measurement. More importantly, the patient doesn't have to twist his/her body to insert the arm in the cuff. This "either arm" design makes people more comfortable during measurement. It is especially convenient for pregnant women, patients with back problems and patients in wheelchairs.



Shown with optional stand

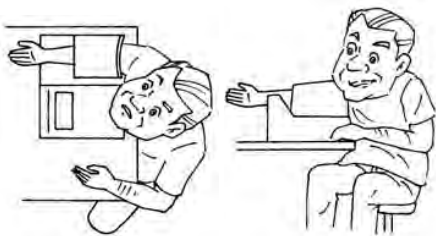

Conventional monitors

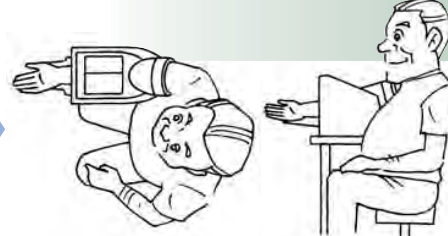

TM-2655

Compact size

The TM-2655 Series has the narrowest width of any fully automatic arm type blood pressure monitor. It has a 40% smaller footprint than our earlier model. This allows the users to properly position themselves without unnecessary arm bending to get a proper measurement. Its compact size relieves you of worrying about where to place the unit.

Pick an arm, any arm

Its compact size and unique "cuff on top" design lets the user measure with either arm.

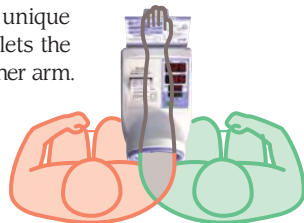

One button operation

Patients can't make a mistake starting the BP measurement. One touch of the START button does it all. Cuff inflation level is set automatically.

Irregular Heart Beat (IHB) indicator

This indicator lights up if an IHB is detected during a measurement. The indicator alerts users of an irregular heartbeat, which could be linked to cardiovascular disease.

(Note: This is for warning purposes only. A&D recommends contacting a physician if this indicator lights up frequently.)

Oscillometric measurement method

The TM-2655 is equipped with the latest oscillometric measuring method. This insures the same stable and accurate BP measurement as in hospitals or doctors' offices.

Quick printout

The TM-2655P prints four different printout formats on wide paper (58 mm/w) to meet various needs. The auto cutter eliminates paper jams caused by the manual tearing of the paper. The time & date is shown on each printout.

Selectable Printout format :

1. Systolic, diastolic & pulse aligned horizontally
2. Systolic, diastolic & pulse aligned vertically
3. Systolic, diastolic & pulse aligned vertically and prints the pulse envelope.
4. Tabular printout

Large LED display

A large, clear LED display shows the measurement results. Systolic, diastolic and pulse rate are clearly shown simultaneously.

Energy saving function

The TM-2655P automatically switches to the energy saving mode approximately 3 minutes after the last measurement. An infra-red sensor, located at the bottom-front of the unit, turns on power automatically when a patient sits at the unit.

Exclusively Distributed by:

WellnessPRO
tomorrow's medical devices

Proper Measurement at Hospitals, Dialysis Clinics and Medical Centers...

Nowadays, fully automatic blood pressure monitors are used in a wider variety of applications. The use of these devices is no longer restricted to visitors checking their blood pressure at health clubs, offices or factories. More and more they are found in use in medical facilities. In some hospitals, patients can take their own blood pressure measurement using a fully automatic monitor before they see the doctor. This "self triage" saves the patients' time and lightens the workload for the medical staff. And with today's technology, the readings are as accurate as if the medical staff took the measurement.



Our unique "either arm" design is especially beneficial in dialysis clinics, where patients take a measurement before and after a treatment. They no longer need to worry about which arm to use. Just insert the arm (without a shunt) in the TM-2655 and press the START button.

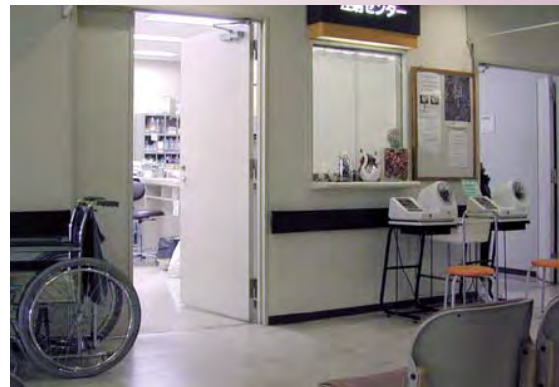

(photo: The TM-2654 in use at the Kitasato Institute Medical Center Hospital, Japan)

Below are 4 examples of the selectable printouts provided by the TM-2655P. You can create your own logo, instructions or comments and easily add them at the bottom of each printout.

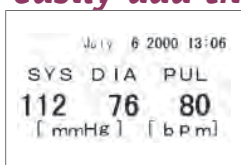

Systolic, diastolic & pulse aligned horizontally

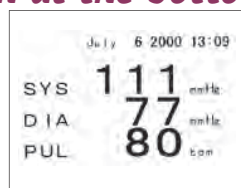

Systolic, diastolic & pulse aligned vertically

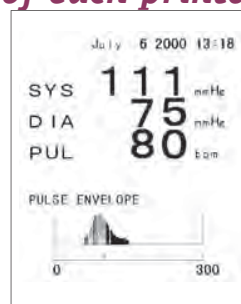

Systolic, diastolic & pulse aligned vertically above the pulse envelope

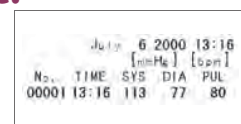

Tabular printout

Printout your advertisement

The new TM-2655P provides a printout with your ad, pharmacy name, etc. on every printout. A large print area (approx.50x50mm) is reserved for your advertisement.



Dual RS-232C ports

The TM-2655 Series is equipped with two RS-232C ports as standard features. This brings more expandability in making a system. For example, one port can be used to connect to a PC while the other one is connected to a card reader. (note: A&D does not provide peripherals or PC software.)

Exclusively Distributed by:

WellnessPRO
tomorrow's medical devices

Specifications

Measurement Method	Oscillometric
Measurement Range	0 ~ 300mmHg (Pressure) 30 ~ 200 Pulse/Minute (Pulse)
Accuracy	+/-3mmhg or 2% (whichever is greater (Pressure)) +/-5% (Pulse)
Display Type	Digital, LED Systolic, Diastolic & Pulse
Pressurization	Automatic Pressurization by Micro Pump
Depressurization	ECEV and Automatic Constant Speed Exhaust Valve (Dual)
Cuff	Geared Motor, Automatic Operation
Safety Device (Electrical)	Quick Release when START Button is pressed Quick Release when EMERGENCY Stop Button is pressed Automatic Rapid Deflation when pressure exceeds 320mmHg Automatic Rapid Deflation / Power Off when pressure reaches 320 to 350mmHg
Safety Device (Mechanical)	Releases Cuff when safety lever is pressed
Clock Function	Clock Display, Date & Time (1999 ~ 2098)
Printer	Thermal Type, 58 mm wide, Automatic Cutter
Power Source	100/115, 220/240VAC, 50/60Hz
Weight	Approximately 9.0 kgs. (19.8 Lbs.)
Dimensions	245 (W) X 325 (H) X 390 (D) mm / 9.6 (W) X 12.8 (H) X 15.4 (D) Inch
Operating Environment	+ 10°C ~ + 40°C (+ 50°F ~ + 104°F), 30% To 85% RH
Storage Environment	- 20°C ~ + 60°C (-4°F ~ + 140°F), 10% To 95% RH

Option and Accessories

Item	Code
Dedicated Stand	TM9325
Adjustable Height Stool (Manual)	TM9312
Adjustable Height Stool (W/Shock Absorber)	TM9315A
Cuff Cloth (5 pcs./Set)	AX-133003442-S
Printer Paper (5 Rolls)	AX-PP147-S
RS-232C Cable	AX-KO1869
Foot Switch	AX-SW135

Dimensions (mm)

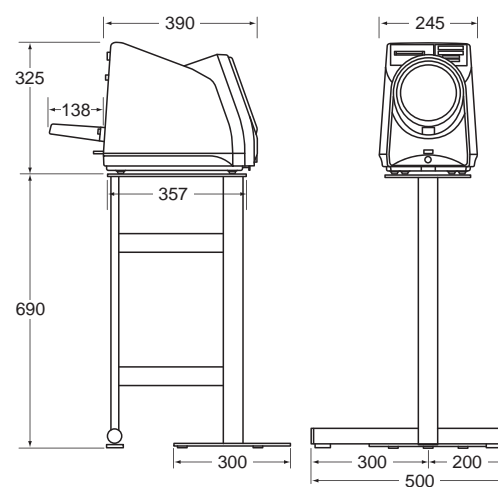

(Shown with optional stand)

Exclusively Distributed by:

WellnessPRO
tomorrow's medical devices