



WellnessPRO

tomorrow's medical devices

PRODUCT CATALOGUE
2015-2016





Guldmann™

DENMARK 

GL5 Mobile Lifter for patient Mobile Lifter with electric width adjustment

"Strength comes from the inside."

FEATURES

- With lifting capacities of 155 and 205 kg
- Low reach – can lift directly from the floor
- High reach – can lift tall users in large slings, without difficulty
- Long reach – with the appropriate type of sling, the GL5 can deal with virtually all lifting requirements
- Versatile – with the appropriate type of sling, the GL5 can deal with virtually all lifting requirements
- User friendly – easy for both tall and short people to use
- Safe – the GL5 is strong, stable and safe (CE marked)
- Reliable – long service life, which means GL5 units can be quickly redeployed to other users without needing service, while the modular design makes servicing straightforward and easy
- Lightweight and easy to move quickly – low-friction castor wheels make the GL5 easy to manoeuvre
- Modern design – integrated, removable battery and electronics, in stylish modern design. The design of GL5 has been matched the Red Dot Award winning design of GH3 ceiling hoist
- All-round capabilities – the GL5 makes it easy to deal with a wide range of lifting and moving situations, at the same time as being ergonomically sound and safe for both carer and user



GL5 Mobile Lifter for patient Mobile Lifter with electric width adjustment



OTHER MODEL



GLS5 Active Lifter

An easy, comfortable and safe way to raise and support users with partial or complete control of the upper body

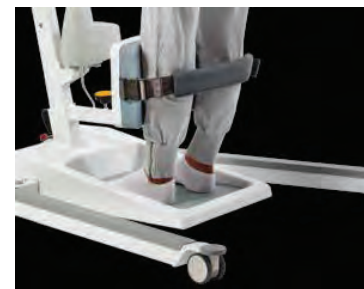

GH3 Ceiling hoist system

The GH3 system is a modular design concept whose classic yet contemporary appearance makes sure GH3 installations blend perfectly with both new and existing buildings, architectural styles and interior design.



GH3 Lifting Module

Lifting module. User-friendly and extremely powerful and fast lifting module for permanent installation. Lifting capacity 200 or 250 kg

Rail Systems

The rails are what the ceiling hoist is installed in, so they are important in making lifting and moving systems work well.

That's why Guldmann rail systems are designed to ensure sure that the hoist moves quietly, smoothly and with a minimum of friction, using as little power as possible. And this smoothness applies right across the capacity range, from 175-500 kg.

OTHER MODELS

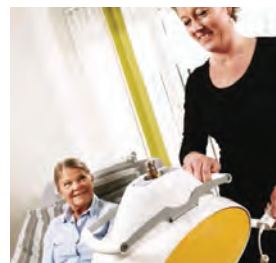

GH1 Ceiling hoist system

The GH1 ceiling hoist system meets all the day to day lifting requirements encountered in smaller environments such as private homes, group homes or homeless shelters. The discreet, classic design of the GH1 system means it takes up very little space.

GH1 F Lifting Module

With the GH1 F you can decide to install rails in more or all of the rooms and settle with a few lifting modules that in the day-to-day care can easily be moved from one room to another.

Kingsystems

INDIANA, USA 

Ambu*
Ideas that work for life

KingVISION™ VIDEO LARYNGOSCOPE

KVL03C

"Intubate with Confidence. Anytime. Anywhere."

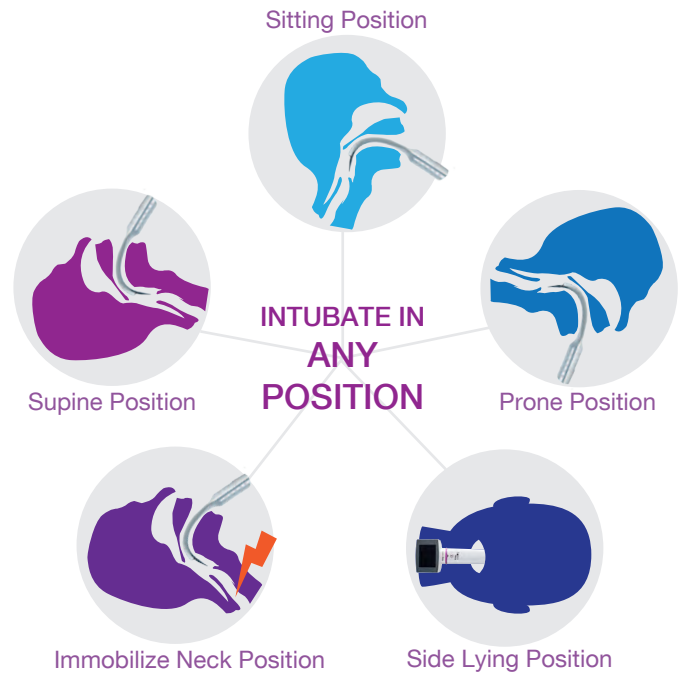

DURABLE

- Designed to be your primary tool for all intubations.
- The robust, full-color, non-glare display can resist repeated cleaning and normal use wear and tear.

PORTABLE

- Light weight, self-contained, battery operated and water resistant.
- The display is packaged in a protective low profile foam case.
- Blades are individually packaged.

AFFORDABLE

- Disposable blades allow economical use of the King Vision video laryngoscope for all intubations.
- The low cost per procedure combined with the high performance visualization capabilities make this the perfect choice for best patient care.

Tens of thousands of airways maintained worldwide!

WELCOME

Here at Wellness PRO, we are committed to facilitate the availability and adoption of better medicine technologies from the established, the best and the globally leading medical device / equipment manufacturers pursuant of better Filipino healthcare.

And, we are excited to bring you in this latest Wellness PRO Product Catalogue winning medical device & equipment innovations specifically vetted for the Filipino patient, for the Filipino medical professional and for the Filipino Healthcare center. We ensured that each device we bring to your attention is applicable and appropriate for today's needs and for tomorrow's scenarios. Yes, Future Proofed! This is to ensure there is the best of value for ALL going forward.

At the same time, we strongly endeavour to be there for you beyond date of installation. We take on the role of being your Healthcare partner. This is the path our company has taken since our establishment in 2004. Now, this is the path we continue on to be truly of service to the various stakeholders of the Philippine Healthcare sector.

We sincerely hope that you find this book most useful.

Sincerely,

Wellness PRO Inc.

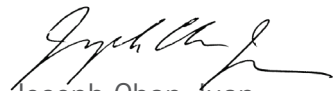

Joseph Chan Juan
President /General Manager



mBCA

medical Body Composition Analyzer

Simplified work, quick measurement
and medically relevant results





The seca mBCA

- Standing aid
- Automatic electrode detection
- Flat platform
- Short measurement time
- Easy entry of patient data
- Flexible storage concept
- Simple user navigation
- Integration in every EMR system
- seca 360° wireless

seca mBCA 515



TABLE OF CONTENTS BY BRAND

DENMARK		Medical Measuring Stations
Elcold 33	Plasma Freezers	Mobile Weighing & Measuring System
Guldmann 2	Patient Lifters	Multifunctional Critical Weighing
FRANCE		Upright & Other Precise Measuring Instruments
Cleanis 17	Absorbent Bags & Bathing Gloves	Seca MBCA 6
Surgiris 54	Operating Room Lights	Seculife 39
GERMANY		Measuring Instruments, Testers & Simulators
KaWe 24	Blood Pressure Measuring Device	ISRAEL
	Diagnostic Set (Ophthalmoscope/Otoscope)	
	Laryngoscopes	Naveh Pharma 16
	Medical Examination Light	Earwax Remover
	Stethoscopes	ITALY
Maico 35	Audiometers	
	Newborn Hearing Screener	Ginevri 18
KaWe Co 9	Breast Pump	Incubator
Medlab 40	Capnograph	Phototherapy
	Pulse Oximeter	Resuscitator
	Vital Sign Monitor	Tecnimed 58
Ophardt 43	Disinfectant Dispenser	Non-contact Thermometer
Seca 46	Height & Circumference Measuring System	JAPAN
	Infant Oriented Scales	
	Mechanical Medical Column & Flat Scales	A & D Medical 12
		Ambulatory BP Monitor
		Digital BP Monitor
		Mercury-Free Sphygmomanometer
		Hadeco 22
		Fetal Doppler
		Vascular Doppler
		Koike Medical 34
		Oxygen Regulator
		SPAIN
		
		Bexen Cardio 15
		Manual & Automatic Defibrillator
		SOUTH AFRICA
		
		Sinapi Biomedical 56
		Chest Drainage
		SOUTH KOREA
		
		Trismed 57
		Fetal Monitor
		SWITZERLAND
		
		Schaerer Medical 30
		Operating Table
		TAIWAN
		
		Karma 11
		Wheelchair
		UNITED KINGDOM
		
		Inspiration 32
		Infant Cooler
		USA
		
		Harloff Medical 44
		Emergency Cart
		King Systems 4
		Video Laryngoscope



▶▶ Contents by device type overleaf

Scope of this book

For you, we proudly assembled innovative & world class medical equipment / device BRANDS. Each quality Brand as found in this book can have up to 220 models & variants – meant to address varying specific medical concerns. Given limitations of space, we have been able to feature only a small subset of the whole range of any one Brand. Accordingly, we invite you to visit the respective Brand's Website. Alternatively, contact us at Wellness PRO to request for a FULL PRODUCT CATALOGUE (hard copy or soft copy) for the Winning Medical Technology Brand of interest to you..

Please note: This book is distributed locally. Colors may differ slightly from those shown in the book, owing to the limitations of the printing process. This book provides a general indication of the range of models, features, optional extras and/or colors available. For current and more specific information in relation to the range of models, features, optional extras and/or colors available and their pricing, please contact Wellness PRO Inc.

www.wellnessproinc.com

TABLE OF CONTENTS BY DEVICE

TYPE OF DEVICE	BRAND	PAGE
Audiometers	Maico	35 & 38
Biomedical Machine Testers	Seculife	39
Blood Pressure Reading - Aneroid	KaWe	27
Blood Pressure Reading - Digital	A & D	13 - 14
Blood Pressure Reading - Ambulatory	A & D	12
Body Composition Analysis	Seca	6
Breastmilk Expression - Pump & Accessories	KaWe Co	9
Capnograph	Medlab	40
Chest Drainage	Sinapi Biomedical	56
Defibrillator - Automatic	Bexen Cardio	15
Defibrillator - Manual	Bexen Cardio	15
Diagnostic Sets (Ophthalmoscope & Otoscope)	KaWe	28 - 29
Disinfectant Dispenser	Ophardt	43
Doppler - Fetal	Hadeco	22
Doppler - Vascular	Hadeco	23
Earwax Remover	CleanEars	16
ECG Machine	Trismed	57
Emergency Carts	Harloff Medical	44 - 45
Examination Lights	KaWe	25
Fetal Health Monitoring	Trismed	57
Fetal Heart Rate Monitoring	Hadeco	22
Hearing Screening	Maico	36 - 37
Infant Cooler	Inspiration	32
Infant Incubator	Ginevri	18
Infant Phototherapy	Ginevri	19 - 20
Infant Resuscitator	Ginevri	21
Infection Control - Commode Liner	Cleanis	17
Infection Control - Patient Hygiene	Cleanis	17
Laryngoscope - Direct	KaWe	24
Laryngoscope - Video	King Systems	4
Operating Table	Schaerer Medical	30 - 31
Oxygen Regulator & Therapy	Koike Medical	34
Patient Lifting	Guldmann	2 - 3
Patient Mobility (Wheelchair, etc.)	Karma	11
Plasma Freezer	Elcold	33
Pulse Oximeter	Medlab	41
Stethoscope	KaWe	26
Surgical Lights	Surgiris	54 - 55
Thermometer - Non-contact	Tecnimed	58
Vital Sign Monitoring	Medlab	42
Weighing & Measuring - Anthropometric	Seca	46 - 53

Office location



Stethoscope **26**

27 Aneroid BP device



Visio Focus **58**



seca mBCA **6**



Otoscope **29**

How we select winning, innovative medical devices/equipment for you, our healthcare partner?

Must be...

- Evidence based
- Indication driven
- Expert/ dedicated manufacturer
- Sustainable value economics
- Better medicine
- Filipino patient responsive

Requiring something else?

---Go to page **59** and tell us at

Wellness PRO

Contents by brand overleaf ◀◀

mamivac® BREAST PUMP

“Conveniently giving all the best for your baby”



MADE IN GERMANY

Sensitive CFH

REF 286000

- Practical stand for mobile use in clinics
- With rechargeable batteries (optional)
- Integrated dual bottle holder
- Continuously adjustable
- Stimulation phase and expressing phase
- Easy to operate



Sensitive C

REF 284000

- The mamivac® 2-phase technology imitates the baby's sucking
- No suction loss with double pumping
- Gentle, hygienic and silent operation guaranteed
- Compact, maintenance-free and durable device
- Germ free – patented protective diaphragm in the suction kit offers the best possible protection and safety for mother and child



Lactive

REF 287000

- Easy to use
- Expressing comfort due to 2-phase technology
- Visual stimulation with a photo of your baby. This stimulus supports the flow of breast milk.
- Time-saving due to optional double pumping
- Best hygienic standard for mother & child



Easy Manual

REF 281360

- The mamivac® 2-phase technology imitates the baby's sucking
- Adjustment valve for continuously adjustable suction strength
- Soft breastshield with massaging effect
- Hygienic as the breast milk flows straight into the bottle
- With the enclosed freezer bag adapter, milk can be expressed straight into a mamivac® FREEZER BAG

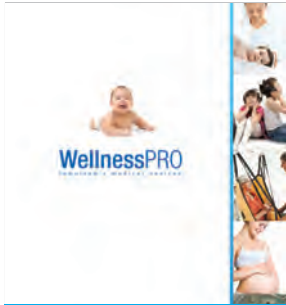

11 years old



over 20,000 device installation to date



over 60% of workforce w/ Medical Training

Supplier Heritage
SECA since 1840
KAWE since 1890
A&D since 1977
GINEVRI since 1954
HADECO since 1948

Office Address: U-1006, Richmond Plaza, San Miguel Avenue cor Lourdes St., Ortigas Center, Pasig City 1605, Metro Manila, Philippines
Tel. No.: +63 2 636-3580, 637-0930, 637-0473; 477-2650
Fax No.: +63 2 6367542
Email: wellnessproinc@gmail.com, info@wellnessproinc.com
Website: www.wellnessproinc.com
Contact: Joseph Chan Juan / General Manager
Date Founded: 09 January 2004
No. of Employees: 25
SEC Reg. No.: CS200400203
DTI Certificate No.: 00275095
Tax Identity No.: 229-021-144-000
FDA Lic. to Operate No.: RDI-MM-MDI-959
Nature of Business: Import / Wholesale Distribution Medical Devices / Equipment / Supplies
Medical Equipment / Device Servicing – Diagnostics / Calibration / Repair
Medical Equipment / Device Rental / Leasing

Advocacies

Training & Continuing Education of Medical Device end users
Mercury Free Healthcare
High Grade Diagnostics
Patient Safety
Maternal & Child Health
Effective Infection Control
Better Medicine Home Care,
Light Nursing Load
Newborn Hearing Screening

Product Lines (among others):

Blood Pressure Device	Diagnostic Sets
Thermometer (Infrared, Digital)	Laryngoscope – Fibre Optic, Video
Medical Weighing Scale	Examination Table
Doppler (Fetal, Surgical, Vascular)	Operating Room Lights
ECG & ECG Holter	Chest Drain Device
Pulse Oximeter	Capnograph
EENT Preparations	Patient Monitors
Stethoscope	Endoscope
Hand Hygiene Touchless Dispenser	Sterlizer
Newborn Hearing Screening	Device Wheelchairs.

Brand / Principals:

A&D (Japan), Hadeco (Japan), Ginevri (Italy), SECA (Germany), Geon (Taiwan), MDF Instruments (USA), Ultrascop (USA), Sinapi (South Africa), Elitech (Indonesia), Tecnimed (Italy), Naveh-Clean Ears (Israel), Infinium (USA), Trismed (Korea), KaWe (Germany), Medlab (Germany), Pedia Pals (USA), Ginevri (Italy), Maico Diagnostics (Germany), King Systems (USA), Ophardt (Germany), Forest Medical (USA), Karma (Taiwan), among others.

Reference Trade Accounts: Available Upon Request
Bankers: Banco De Oro – Blumentritt Branch
Bank of the Philippine Islands – Ortigas San Miguel Branch
LandBank of the Philippines – Pasig Branch



7,100 islands



100M Filipinos



2,000,000 babies born each year



42,000 barangays



72.5 years
66.4 years
Filipino Life Span

WHEELCHAIR

"Performance, Style and Comfort"

Karma

mobility solutions

TAIWAN 



S-Ergo 125
KM-1520.3





The unique S-Ergo seat has been shaped to promote pressure redistribution by spreading the load over a greater contact area.

The shape of the seat also helps stop the user sliding forward in the seating area.



Pressure redistribution

Reduced sliding

			
Traditional seat High risk of causing decubitus ulcers because of pressure points concentrating at hipbone area.	S-Ergo seat The S-Ergo system (intelligent s-shaped ergonomic seating) provides efficient pressure redistribution by spreading weight over a greater area, at the same time provides stabilization and reduced sliding.		

FEATURES



Flip-back armrest

Flip-back armrest offers greater convenience. (S-125)



Extended armrest

Extended armrest design allows wider seating area whilst minimizing overall width of the wheelchair.



Ergonomic arm pad

Wider arm pad is ergonomically designed to offer comfortable support for elbow and the new arm tube design allows easier movement.



Ergo Handrim

The innovative Ergo handrim has patents in many countries. It offers comfort and assists with wheelchair propulsion.



Swing-away footrest

Inward / outward swing-away footrest for added convenience. Structure, offers great comfort and stabilization to both thigh and leg. (S-125 / S-115)



Quick release rear wheels



AMBULATORY BLOOD PRESSURE MONITOR

24 hour ambulatory BP monitoring

TM-2430



FEATURES

- 24 hour ambulatory blood pressure monitoring
- Lightweight and compact size
- Oscillometric measuring method
- Battery power (3 alkaline or Ni-Cd / Ni-MH "AA")
- Data output to computer or printer
- RS-232C connectivity

Doctor Pro Windows™ Software

- Setting up all the parameters
- Various formats of graphs for further diagnosis
 - Trend
 - Circadian rhythm analysis
 - Correlation
 - Hyperbolic index analysis
 - Histograms

The **A&D Medical Ambulatory Blood Pressure Monitoring** System (ABPM) allows health care professionals to automatically monitor a patient's blood pressure throughout the day. ABPM therapy can help differentiate hypertension from white coat hypertension and the data generated can be used to adjust patient medication levels. This compact monitor has sophisticated tracking capabilities to measure blood pressure and pulse trends.



DIGITAL BLOOD PRESSURE MONITORS

"Loving BP Care, Same BP Model, Going 10 years strong!"



UA 767 plus

FEATURES

- Irregular Heart Beat Indicator
- Clinically Validated
- Blood Classification Indicator
- 1 Touch Measurement
- Smooth & Fast Measurement
- Accurate to plus / minus 3mm Hg



OTHER MODELS



UA 651

- Latex and metal free, SlimFit Cuff
- Irregular HeartBeat (IHB) indicator
- WHO Blood Pressure Classification Indicator
- 30-memory + average reading



UA 621

- Irregular HeartBeat (IHB) indicator
- WHO Blood Pressure Classification Indicator
- Large 30-memory + average reading
- SlimFit comfortable cuff
- Standard AC adapter inlet



TOKYO, JAPAN

MERCURY-FREE SPHYGMOMANOMETER

with PULSE RATE & MARKING FEATURES

UM-101

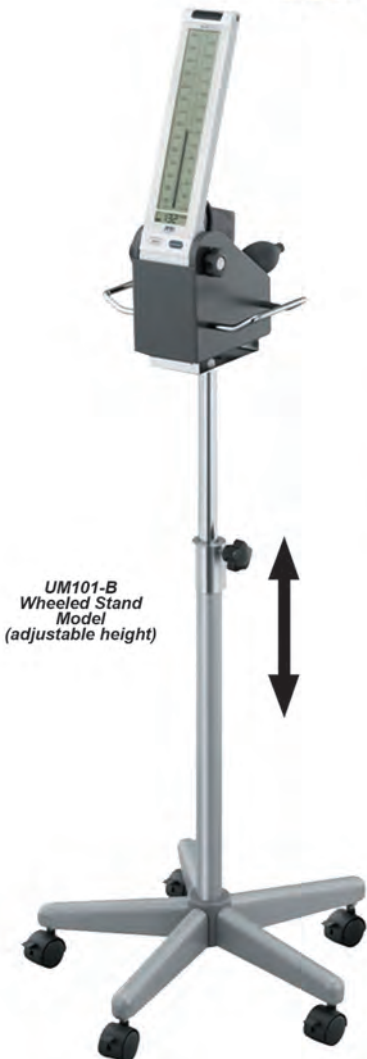

**Compliant
with
DOH AO No.:
2008-2021**



- **Auscultatory**
- **Sleek, robust and easy to carry**
- **Alerts when BP taken incorrectly**

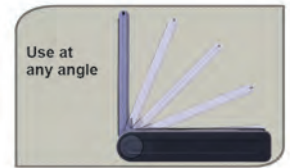

UM-101 DIRECT COMPARISON!
A&D UM101 vs. Mercurial Manometer
at: <http://www.youtube.com/watch?v=9mgTPHSQVWM>
or search YouTube using the keyword:
UM-101 Mercury Free Sphygmomanometer

REANIBEX 800

DEFIBRILLATOR MONITOR

"Ready for Life"

FEATURES

- Manual and Automated Biphasic Defibrillator up to 360 Joules.
- Lightweight equipment with monitoring and diagnostic capabilities.
- Large colour display (8.4").
- Synchronized Cardioversion.
- 3, 5 and 10-lead patient cable.
- High performance with ease of use and very intuitive.
- Modular. Easily upgradeable.
- Plug and play system to add new options.
- 12-lead ECG data transmission from the field to the Emergency Service.
- Masimo Rainbow SET technology that monitors SpO2, Carboxyhemoglobin and Methemoglobin.
- Oridion capnography. Microstream technology.
- Non-invasive Blood Pressure from SunTech Medical.
- Operates from the mains (AC). from a vehicle battery (DC) and with its internal battery.



reddot design award
product design 2013

OTHER MODELS



REANIBEX 700

- Biphasic technology.
- Truncated Exponential Waveform adapted to patient's impedance.
- Simple and intuitive.
- Portable and lightweight.
- Control of the defibrillator and the printer from the paddles.



REANIBEX 500

- Biphasic Manual and AED Defibrillator up to 360 Joules.
- Lightweight unit with monitoring capabilities (IEC 60601-2-27).
- Large colour display 5.7".
- 3-lead patient cable.
- Synchronized Cardioversion.



REANIBEX 300

- Biphasic AED or AED with Manual override option up to 360 Joules.
- Large colour display 5.7".
- Universal AED algorithm for adult and paediatric patients.
- Automatic daily self-test ensures the device is always ready for use.



REANIBEX 200

- Biphasic technology.
- Truncated Exponential Waveform adapted to patient's impedance.
- Energy delivered: 200 joules.
- Lithium battery with more than 300 discharge of capacity.



CE001

(BFAD LTO # PDI-MM-MDI-959)
(BFAD CPR # DVR-6279)

Ingredients:
Mineral Oil, Phytosqualan, Spearmint Oil.

DIRECTIONS:
Spray 1-2 puffs in each ear 3 times daily until wax is removed.

CleanEars

For Ear Wax Removal | Wash & Dissolve Jet Spray

Recommended by Philippine Pediatricians since 2008



FEATURES

- Double Action: Wash and Dissolve
- Made in Israel
- No need to tilt head to use
- Economical at about 100 puffs/bottle
- Prevents ear plugging
- Safe and Effective
- Clinically Tested
- Minimizes Picking
- Good for all ages
- No preservatives
- Softens Ear wax
- Long shelf life
- User friendly

SUPER ABSORBENT BAGS

Commode Liner
ACL 7831738



CareBag
sacs absorbants • absorbent bags



With Super Absorbent Pad

DESCRIPTION

A patented unique bag
The CareBag® absorbent bag is the unique combination of an easy-to-close hermetic bag equipped with a GelMax® Super Absorbent Pad inside.
The active particles in the pad quickly solidify fluids and materials upon contact. Once sealed, the risk of spills, splashes and odors are significantly reduced. It can easily fit most containers (bedpans, buckets, basins, etc) that are potentially infectious.



Men's Urinal Bag
ACL 7733993



Travel Kit
ACL 9538557



Vomit Bag
ACL 7733987



Eco Bag
ACL 9989891



Toilet Bowl Liner
ACL 9538534



Bedpan Liner
ACL 7711141



Toilet Kit
ACL 9829183



Toilet Box
ACL 9832529

OTHER PRODUCTS



Cleanis invented a Range of Pre-Moistened Gloves No-Rinse Bathing and Shampoo Gloves

The Aqua® Toilet or Shampoo wash glove is made of a very resistant non-woven embossed material, extremely soft (90g/m², 40% viscose), pre-moistened with a no-rinse, protective wash lotion, dermatologically tested, hypoallergenic, alcohol-free and soap-free.
The single-use glove is enhanced with an internal protective liner protecting the nursing staff from possible contamination and can be reheated in the microwave for greater comfort.

GINEVRI

Quality for life

Rome, Italy 

60 years in neonatal incubators



*Ensure life from
one faint breath
to the next*

Polytrend
Polytrend
Neonatal Incubators

Model: OGB8070

SPACE AGE POLYCARBONATE HOOD

INFECTION CONTROLLED RELIABLY

SURVIVAL ENHANCING WARM BUBBLE OF AIR

FAIL SAFE CONTROLLED TEMPERATURE



**SUPERIOR
INFECTION CONTROL
AND
CONSISTENT
HEAT LEVEL MANAGEMENT**

MIRA PHOTOTHERAPY LAMP

COD-8095



DESCRIPTION

The phototherapy lamp MIRA, uses last generation POWER LED technology to produce therapeutic blue light (425-475nm) and fiber optics to dose the therapy on infant babies with jaundice. It has a light and compact design with a "soft touch" control panel where are present warnings, alarms and a wide display indicating therapy times, visible up to a 7m distance.

The therapeutic radiation, produced by a HIGH POWER LED, is transferred, through a flexible fiber optic cable, to a small dimension pad that must be positioned in contact with the patient's skin.

FEATURES

- therapeutic radiation, produced by a HIGH POWER LED, is transferred, through a flexible fiber optic cable.
- compact design with a small dimension pad that must be positioned in contact with the patient's skin.
- portable and can be placed on a shelf or a trolley.
- LED life over 20,000 hours of use at high intensity.

CONSUMABLES



1645
Eye mask (Pack of 50 pcs)



7337
Pad Cover (Pack of 24 pcs)

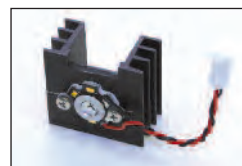

12853A73
Optic Group (1pc)



7291A72
Pad (1pc)

GINEVRI

Quality for life

Rome, Italy 

NAOS PHOTOTHERAPY LAMP

COD-8082

DESCRIPTION

The new NAOS Lamps are the fruit and result of recent studies carried out on the efficiency of the new Power LEDs for the treatment of hyper-bilirubin in newborns. The lamps are equipped with 6 Power Blue LEDs for treatment of jaundiced newborns. Illumination is provided by 4 Daylight White LEDs which make clear and accurate observation of the newborn possible.

FEATURES

- Equipped with 6 Power Blue LEDs for treatment of jaundiced newborns.
- Provided with 4 Daylight White LEDs which make clear and accurate observation of the newborn possible.
- Equipped with mechanical time counter to check the light of the LEDs and of the therapy hours carried out



ACCESSORIES AND CONSUMABLES



12129A70
Stand
(135-180 cm)

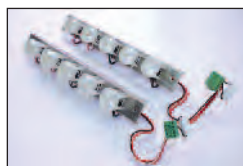

12172A73
Optical Unit - Phototherapy
and Illumination Leds (2 pcs)



1645
Mask for Phototherapy
(50 pcs)



1749
Radiometer RM400

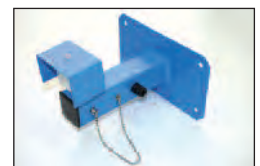

12423A70
Wall Support



BABY START

INFANT T-PIECE RESUSCITATOR

BS-8000

DESCRIPTION

The Baby Start is a light weight Infant T-piece Resuscitator, suitable for Delivery Suite, Post Natal Wards, Community Theaters, Special Care Baby units and Neonatal Intensive Care Units. Current resuscitation guidelines recommend the use of T-Piece device with the potential benefits of achieving controlled target PIP and delivering consistent PEEP to help establish FRC and improve lung volume.

FEATURES

- Simple and efficient device to resuscitate asphyxiated neonates by mask or endotracheal tube.
- Resuscitation pressures (PIP and PEEP) are easily readable on the fast response manometer.
- Uses a single use patient circuit completed with a expiratory valve and silicone neonatal mask.
- Can be installed, by dedicated support, on Infant Warmers, on Transport Incubator or Resuscitation Trolley.

ACCESSORIES



11574A70
Reusable Test Lung 1pc

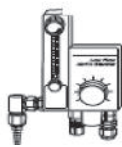

12409A70
Gas Blender 1pc



422
Single Flowmeter 1pc

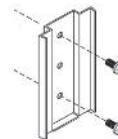

1014A40
Multi-Use Support 1pc



8049
Humidifier "Wetty" 1pc



KAWASAKI, JAPAN

FETAL DOPPLERS

*Real time,
Great sounds!*



Hadeco 806

ECHO SOUNDER ES-102EX

Desktop Fetal Doppler with LCD and Large Speaker

- AC/DC; Hold Option on Reading, 5 hours battery life
- Ideal for hospital and delivery centers

Hadeco 804

BIDOP ES-100 V3 2Mhz

Large LCD Fetal Doppler
Good for Fetal Heart Rate
Count and/or Monitoring

- 30 waveform memory
- Great sounds at 50 mm diameter speaker



Hadeco 805

SMARTDOP 45 2Mhz

Printer Fitted Handheld Fetal Doppler
with Large LCD Display

- Option for Smart-F-Link Software
- 2.5 hours or more battery life



Hadeco 803

MINIDOP ES-100 VII 2Mhz

Handheld Fetal Doppler with LCD
Numerical Display and
Waterproof Probe



Hadeco 802

MINIDOP ES-100VX 2Mhz

Pocket Size Fetal Doppler with Easy
Probe On/Off Button

- Performs best in OB-Gyne Clinic Settings



Hadeco 801

ECHO SOUNDER ES-101EX

1 Hand Operation Cellphone Size Fetal
Doppler with LCD

- Used by Leading Philippine OB-Gyne Doctors already!
- 3 Counting Modes Built In



Bidop ES100V3

Bi-Directional Doppler

FEATURES

- 30 memory storage**
 Save waveforms and numerical data for later use or download to optional Smart-V-Link software.
- USB computer interface & optional software**
 Transfer waveforms and numerical data to a computer for data storage and documentation
- Optional PPG (photoplethysmography)**
 For toe pressures and venous reflex studies
- Auto gain control**
 Bidop automatically adjusts the gain and baseline for ease of use.



The Hadeco Bidop is a bidirectional Handheld Doppler with LCD display. The LCD Display shows the wave form of the blood flow of the pertinent periphery. It is bidirectional allowing you to do venous reflux analysis too. The Hadeco bidop as standard comes with a 8mhz probe allowing you to listen for blood flow sounds of and to view wave forms for various arteries - brachial, radial, femoral, posterior tibial, dorsalis pedis, ulnar, and popliteal.

We can readily add (at very nominal charge) a PPG probe allowing you to diagnose the blood flow at the digits. At the same time, you have the option to have the Smart V Link Software that will record the wave forms, compute the pertinent ABI and TBI with you just inputting the systolic numbers. The same Hadeco Bidop and smart v link software can be used for the carotid.

Diagnosis is the First Step!

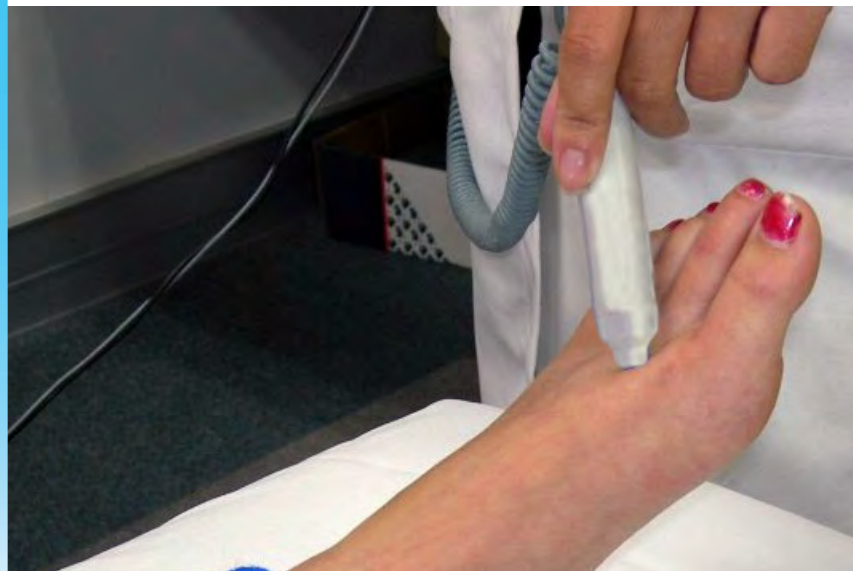

FIBRE OPTIC (F.O.) LARYNGOSCOPES

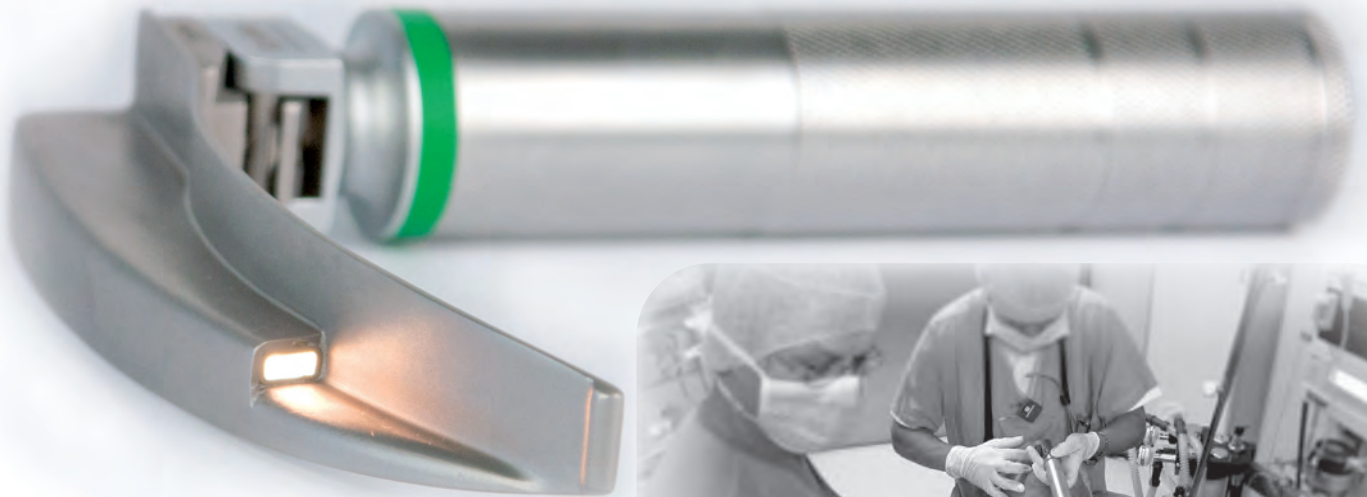

KaWe MEGALIGHT® MACINTOSH F.O.
03.42244.621

FEATURES

- Matt finish stainless steel
- With integrated fibre optics
- No dust collecting cracks (easy to clean)
- Very large fibre optics
- Meaningful brightness
- Autoclavable
- Fits with KaWe and other DIN EN ISO 7376 handles
- Maintenance-free

OTHER TYPES OF BLADE



A. KaWe FLAPLIGHT® MEGALIGHT®

OTHER TYPES OF HANDLE



Conventional handles come in same size / type as F.O. handles except for **A** and **B**



B. Polio Macintosh F.O.



C. KaWe FLAPLIGHT® F.O.



D. Foregger F.O.



E. KaWe MEGALIGHT® Macintosh F.O.



F. KaWe MEGALIGHT® Miller F.O.



G. Macintosh F.O.



I. TEPRO® Macintosh F.O.



H. Miller F.O.



Economy Blade also available

conventional / non-fibre optic models also available, call for more details

MEDICAL EXAMINATION LIGHTS

MEDIZINTECHNIK
seit 1890
KaWe
GERMANY

KaWe MASTERLIGHT® Classic

10.12010.002

See it clearly...

Working with a **KaWe MASTERLIGHT®** medical examination lamp is like working in full daylight. The light can be focused precisely. With the brightness adjustment switch, the lamp can be adapted to any needed lighting situation. Even the smallest colour nuances in the tissue can be seen thus making it easier to make a precise diagnosis and perform safe treatment.

OTHER MODELS

KaWe MASTERLIGHT® Classic **LED**

10.11020.002

Flexible LED examination light with 5-foot, rolling floor stand made of high-quality stainless steel

- Modern, slim design
- Precise light spot
- Easy to use, freely adjustable
- Supply voltage: 230 Volt
- Lamp: 12 V/10 Watts (80% less energy compared to 35W)
- Reflection angle: 24°
- Colour temperature: approx. 3000° Kelvin
- Easy and quick assembly
- With universal power plug

KaWe MASTERLIGHT® 30

10.71030.002

Examination light for diagnosis and minor surgical procedures with a dielectric light system

- Fixed focus
- With 5 foot powder coated mobile floor stand
- Excellent color rendering
- Brightness control is infinitely variable (0-100%)
- On/off switch on the light body
- Exact positioning of the light with the handle and the outside handle bar
- Infinitely variable electronic brightness control with on/off switch (rotary potentiometer) on the light body
- Easy to maintain
- Cold light



STETHOSCOPES

KaWe STANDARD-PRESTIGE Stainless steel stethoscopes



FEATURES

- Dual-head stethoscope
- Stainless steel
- Diaphragm Ø 44 mm
- Tube length approx. 56 cm
- Reversible
- 2 pairs of spare ear tips, spare diaphragm and name plate



The **KaWe PRESTIGE** Line stethoscope is equipped with a solid dual-headed chest piece made of stainless steel. This stethoscope satisfies every requirement profile. Available in various sizes, it can be used for babies, children and adults (Baby, Child, or Standard-Prestige) and will serve you well day after day for any requirement and/or specialised field. The single-tube system with integrated head piece is available in different colours. Each stethoscope comes equipped with two spare pairs of ear tips, one spare diaphragm and a name plate.

Auscultation of the heart...

STETHOSCOPE OPTIONS



06.22700.172



06.22702.032



06.22701.022



BLOOD PRESSURE MEASURING DEVICE

MEDIZINTECHNIK
seit 1890
KaWe
GERMANY

KaWe MASTERMED® C

04.32730.232

The **KaWe MASTERMED® C** Premium blood pressure monitors provide clinicians the highest level of quality and value. The instruments in this series are defined by their innovative and practical features, smooth surfaces for easy cleaning, and particularly precise gauges. These blood pressure monitoring devices are available as wall-mounted, table top and freestanding models. These units have a double-walled housing that ensures additional stability and protection and are therefore designed to withstand twice the pressure. Each model comes with a generously-sized cuff holder.

FEATURES

- Complies with DIN EN ISO 81060-1 standards
- Clear gauge with thin, red dial for exact measurement readings
- Numbered instrument dial reduces the risk of parallax
- 150 mm dial diameter
- Scaling: 0 - 300 mmHg
- Beryllium-copper diaphragm maintains the calibration up to 600 mmHg
- Nylon-Velcro adult-sized cuff with polyurethane bladder
- Plug-in adapter for quicker cuff exchange
- Stays calibrated for 5 years, guaranteed
- 2-year guarantee on device when used properly

OTHER MODELS

Wall-mounted Wheeled-stand



KaWe MASTERMED® ANEROID A2

04.12200.63

The **KaWe MASTERMED® A2** is a double-tube aneroid sphygmomanometer featuring a large, clear 58mm diameter scale. Available in a choice of three colours, the A2 manometer is supplied with a standard adult latex-free cuff and a colour co-ordinated zipped bag.



FEATURES

- 2-hose-system
- 58 mm scale diameter
- Measuring accuracy compliant with DIN EN ISO 81060-1
- Scale setting 0 - 300 mmHg
- Attractive, safe plastic housing
- Adult-size nylon-velcro cuff with polyurethane bladder
- In zippered storage bag

CUFF SIZES



DIAGNOSTIC SET **OPHTHALMOSCOPE**



KaWe PICCOLIGHT® E56 / US 01.23566.021

- Battery handle (AA)
- 2.5V halogen bulb
- With correction lens wheel in stages from +/- 20 dioptres
- Aspherical precision optics
- In cloth bag
- Batteries: 2 Mignon, 1.5V (type AA)
- 6 diaphragms



6 Diaphragms

I

●

●

●

●

●

US

Blue filter



Other models available

KaWe EUROLIGHT® E36 3.5 V 01.25361.101

- Clic closure
- High-capacity 3.5V halogen bulb
- Metal charging handle C
- Dimmable rheostat
- With correction lens wheel in stages from +/- 20 dioptres
- Included 3.5V Li-ion rechargeable battery (*only to be used with KaWe Medcharge® 4000 charging station*)
- In bag with zipper 6 diaphragms

3,5V

NEW

Excellent, uniform illumination!
Very large examination field
of the fundus of the eye.



DIAGNOSTIC SET OTOSCOPE



KaWe EUROLIGHT® F.O. 30 LED

01.11530.002

- Clic closure
- LED bulb
- Illuminance approx. 8,000 Lux
- Lifetime approx. 100,000 h
- Metal battery handle C
- Dimmable rheostat
- Disposable ear funnel
10 x Ø 2.5 mm, 10 x Ø 4.0 mm
- In bag with zipper
- Batteries: 2 C batteries

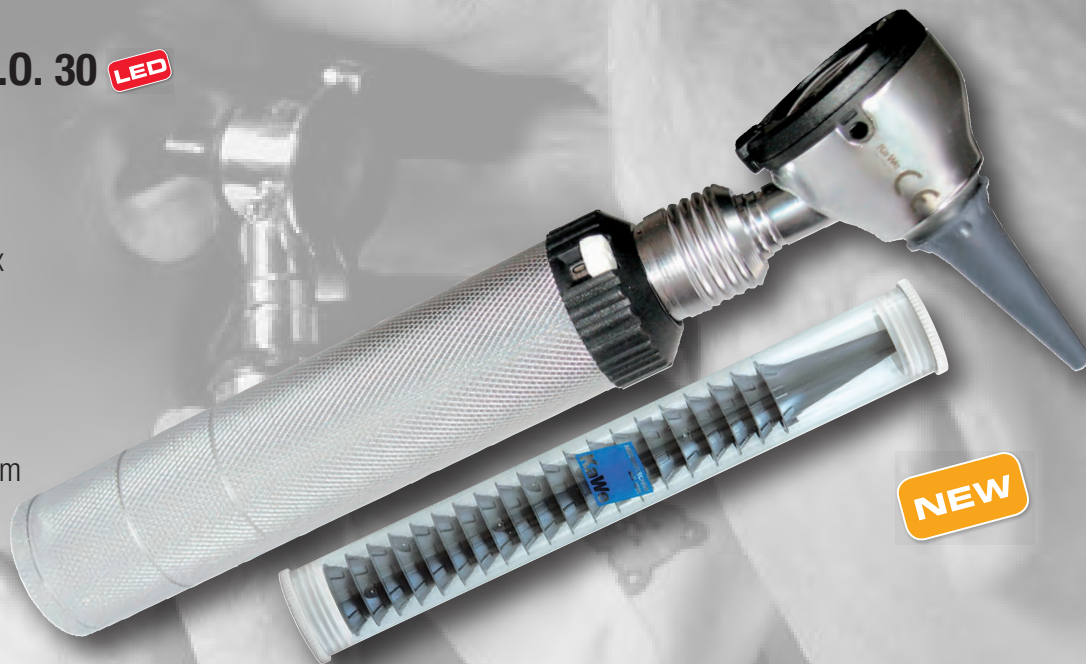

NEW

3,5V F.O. LED high power NEW

KaWe COMBILIGHT® F.O. 30 LED

01.12830.101

- Clic closure
- LED bulb
- Illuminance approx. 8,000 Lux
- Lifetime approx. 100,000 h
- Metal battery handle C
- Dimmable rheostat
- Disposable ear funnels
10 x Ø 2.5 mm, 10 x Ø 4.0 mm
- Incl. 3.5 V li-ion rechargeable battery (only to be used with KaWe MedCharge® 4000 charging station)
- In bag with zipper



F.O. LED high power NEW

KaWe PICCOLIGHT® F.O. 30 LED

01.13600.022

- F.O. LED illumination
- Illuminance approx. 30,000 Lux
- Lifetime bulb approx. 100,000 h
- Shockproof and energy-saving
- Battery handle AA
- Disposable ear funnels
10 x Ø 2.5 mm
10 x Ø 4.0 mm
- In cloth bag
- Battery: 2 Mignon (type AA)



night sky stone

schaerer® axis

400 / 500 / 600 / 700 / 800 series

Mobile operating tables for all disciplines

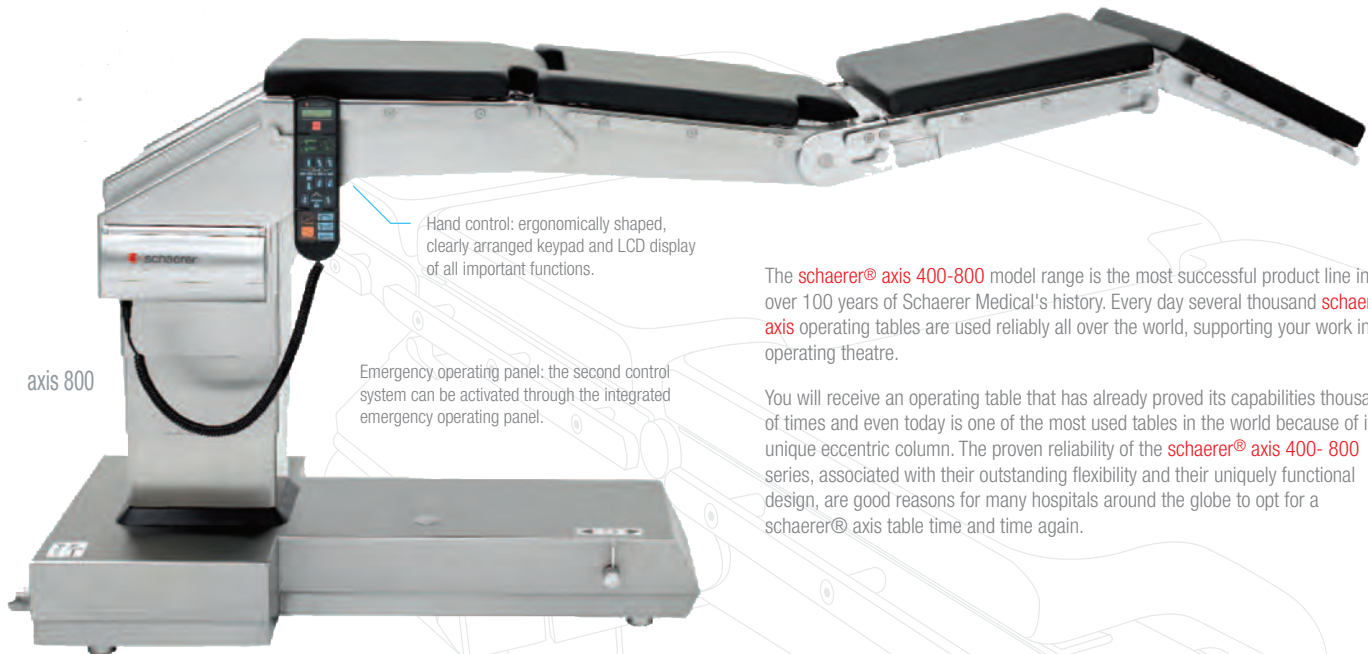

axis 800

Hand control: ergonomically shaped, clearly arranged keypad and LCD display of all important functions.

Emergency operating panel: the second control system can be activated through the integrated emergency operating panel.

The **schaerer® axis 400-800** model range is the most successful product line in over 100 years of Schaerer Medical's history. Every day several thousand **schaerer® axis** operating tables are used reliably all over the world, supporting your work in the operating theatre.

You will receive an operating table that has already proved its capabilities thousands of times and even today is one of the most used tables in the world because of its unique eccentric column. The proven reliability of the **schaerer® axis 400-800** series, associated with their outstanding flexibility and their uniquely functional design, are good reasons for many hospitals around the globe to opt for a **schaerer® axis** table time and time again.

MAXIMUM ECCENTRIC COLUMN

Maximum access for the surgeon, nurses and technicians without additional longitudinal shifting even where space is limited. Table top area offside the column up to 1990 mm and X-ray transparent table top area (up to 1900 x 370 mm).

MAXIMUM STABILITY

The use of high quality Swiss materials and components ensures strength and a long service life. 220 kg / 485 lbs all position dynamic weight capacity.

MAXIMUM SAFETY

Only Schaerer operating tables have two independent motor pump systems that can work powered by batteries for several operating days.

POSITIONS



Maximum free space for C-arm utilisation in the basic position



Maximum free space for C-arm utilisation in the reverse position

GENERAL SURGERY



Cholecystectomy positioning table top from the column 1600mm, thereof 1450 mm X-ray transparent (schaerer® axis 400/500/600)



Positioning for hand surgery with hand surgery plate without floor support



Rectum positioning

GYNAECOLOGY / UROLOGY



Laparoscopic interventions with leg holders «InfiniMax» and intermediate plate



Gynaecological and urological intervention with leg holders «LEG-TOP» for flat and lithotomic positions



Lateral positioning for nephrectomy and posterior-lateral spinal column surgery

NEURO SURGERY



Intervention in supine position in reverse position with original DORO® accessories (teflon covering) and universal adapter



Intervention in supine position in reverse position with original DORO® accessories (aluminium) and universal adapter



Positioning for spinal surgery

SHOULDER SURGERY

Intervention on the shoulder with shoulder arthroscopy plate and head rest narrow



Intervention on the shoulder in reverse position schaeerer® axis 500/700 with orthopaedic seat plate and head rest narrow



Intervention in the head and cervical area in reverse position with shoulder arthroscopy plate and facial / occipital head rest

TECOTHERM NEO Total Body Cooling & Unique CFM

A unique partnership for treating HIE



Code: TC-NEO-SK

Total body cooling to the next level...

FEATURES

- 3 modes of operation for maximum flexibility in use
- Clinician can set and adjust parameters at the start and throughout treatment
- Data storage for allowing simple analysis of temperature profiles
- USB output
- Large colour screen is easy to see across the room
- Benchtop mountable for space saving
- Small / Lightweight portable device
- Internal battery restarts from same settings in event of power failure
- Smooth, linear rewarming
- Compatible with reusable or disposable rectal probes
- Optional use of skin probes

MODES OF OPERATION

- Servo-Control Complete Treatment Mode
- Servo-Control Mode (Constant Rectal Temperature)
- Constant Mattress Temperature Mode

NEONATAL CLINICAL APPLICATIONS

- Determination of severity of HIE (Diagnosis/Prognosis)
- Determination of Seizures (Clinical/Subclinical)
- 34+ weeks GA well defined in literature
- Long term monitoring (cooling HIE patients)
- When EEG not available (out of hours?)
- When long term EEG is not available (lack of technology)
- Prematurity

CLINICAL BENEFITS

- Long term bedside tool for Neonatologists
- Easier to review than EEG
- Good Sensitivity / Specificity / PPV / NPV
- Combined with existing clinical diagnosis



UNI

PLASMA FREEZERS

- Low service costs
- Long life
- Short term storage of blood and plasma



UNI 31



PERFECT and RELIABLE
LOW TEMPERATURE STORAGE

OTHER MODELS



UNI 11



UNI 21



UNI 41



UNI 51

FLOW GENTLE+ OXYGEN REGULATOR

“High Degree of Usability and Safety”

FEATURES

- Easy to view the flow setting
With a big window of the green transparent cover display and large size of the numbers in black on white, the flow setting is easily checked and adjusted in one glance.
- Green Rubber Protection (G/BS/CGA/Y)
The pressure gauge is designed to prevent from a damage of unexpected impact and falling in the event of the cylinder getting knocked over by placing the gauge at the top of the regulator with a green rubber protection. The dome shape makes easy-to read the gauge.
- A spanner is not required (G/BS/CGA/Y)
With the green rubber hand grip, it is easy to connect and disconnect without a spanner.
- Fail-Safe Structure that prevents heat (G/BS/CGA/Y)
The primary pressure chamber is made of brass with an Adiabatic Compression Heat Preventing Structure. This feature prevents oxygen from igniting by the cylinder valve being open rapidly.



G/BS/CGA type
For Oxygen Cylinder with Thread Valve
G-10L

OTHER PRODUCT

safetyflow OXYGEN FLOWMETER P-321



- Simple structure. There are only few parts, so maintenance is easy.
- Clearly visible float tube. You can set the flow rate very easily.
- Safety structure equipped with an alarm.
- Very easy to refill using disposable refined water.

OTHER MODEL



P type (JIS) For Medical Outlet (Oxygen Gas) P-10L

- User Friendly - Oxygen flow rate has a large display for easy dial setting.
- Easy-to-Operate - Flow Gentle+ G and P both have a soft grip handle for easy connection and disconnection.
- Protected Gauge - Pressure gauge is positioned at the top of the regulator to protect it from direct collision in the event of accidental contact or tipping.

MAICO MA25

Easy and mobile basic screening audiometer



BERLIN, GERMANY 



FEATURES

- New features combined with a fresh design
- Air conduction with 11 frequencies from 125 Hz to 8 kHz
- Customize the frequencies according to your own needs
- Intensities from -10 dBHL to +100 dBHL in steps of 5 or 1 dB
- Pure, warble and pulse tone
- Independent with battery or eco-friendly with power supply
- **MA 25e** with automatic test according to Hughson-Westlake

The **MA 25** is the ideal audiometer wherever quick basic hearing screening evaluation is needed. It is our smallest and lightest independent audiometer.

Full range test options

The **MA 25** offers a full range of testing opportunities. Frequencies range from 125 Hz to 8000 Hz and signal intensities run from -10 dBHL to 100 dBHL. Pure, pulse and warble tone make it complete.

*...Easy to use
Reliable engineering...*



MAICO MB11 BERAphone®

AABR Newborn Hearing Screener

#701174



Why screen via AABR method?

Screening with auditory brainstem response is a direct test of the entire auditory pathway up to the brainstem. It also detects auditory neuropathy and other neural defects which cannot be found with OAE measurements.

With the MB 11 BERAphone® you get automatic ABR at the speed and cost of OAE measurement and with very high sensitivity and specificity.



FEATURES

- Automatic, Reliable ABR-screening Results
- Innovative BERAphone® design given cost saving integrated electrodes
- CE-Chirp-Stimulus / Impedance Check for fast results
- Automatic Impedance Check indicates impedance conditions
- Easy Pc Connectivity for Power / Data Transfer

User-friendly software

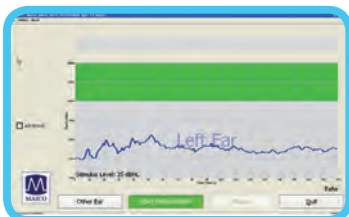

The special evaluation software performs the test automatically and the Pass or Refer Result will show within a few seconds.

"AABR testing is the GOLD standard.."

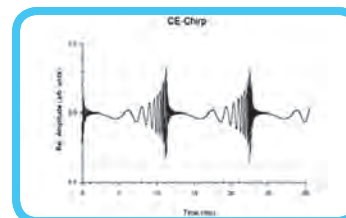

The new CE-Chirp Stimulus

The CE-Chirp™ stimulates all regions of the cochlea at the same time and generates much higher responses than a standard click. It delivers most reliable screening test results even in normal ENT-offices.

Time course and frequency spectrum of the cosine functions used for the CE-Chirp™ Stimulus

MAICO ERO·SCAN™

OAE Test Screener System

#701142 / 701143 / 701146



BERLIN, GERMANY

Why Use Otoacoustic Emissions (OAEs)?

Otoacoustic emissions are sounds that are produced by the cochlea (outer hair cells) and can be measured in the ear canal. When sound passing through the ear canal reaches the cochlea, the vibration stimulates thousands of tiny hair cells. This creates a byproduct that can be detected and measured.

OAEs only occur in a normal cochlea with normal hearing sensitivity. If there is damage to the outer hair cells, which produces hearing loss, then OAEs will not be present. In general, OAEs will be present if hearing is at 30 dB or better. PASS test results mean OAEs were detected. If there is damage to the outer hair cells producing a mild hearing loss, OAEs may not be present. The test result is REFER and the patient may be at risk for possible communication handicaps and can benefit from further diagnostic assessment.



"It's so easy...!"



FEATURES

- Test both ears in less than a minute
- Results are displayed as PASS or REFER
- Test is completely objective (no response from the patient is necessary)
- Option to print the results
- Accurate results
- Can come in DPOAE, TEOAE or combo versions

OAE-Software



PC connectivity for optional software for report storage

BERLIN, GERMANY 

MAICO MA50

Air and bone conduction audiometer



The ergonomical **MA 50** has a rugged, integral carrying case with ample storage for all accessories. The soft, comfortable handle and lightweight 5.8 kg / 12.8 lb including accessories - makes transporting the instruments easy. It takes less than one minute to open the front cover, connect to power and start to operate.

Noteworthy features and benefits

Tracking is just one of the special features that make it easy to operate the instrument.

Easy to operate with ergonomic design

The **MA 50** is fast and easy to operate. The unique detented intensity level control knob can be operated from the top or side. Locating the interrupt/presentation bars and frequency buttons adjacent to the intensity knob allows one handed control. Sensible keyboard layout with LEDs for each function ensure error free operation. The bright LED display shows frequency and intensity level settings.

FEATURES

- Air and bone conduction
- Continuous, pulse and warble tone, masking noise
- Lightweight - only 5.8 kg / 12.8 lb including accessories
- Ergonomically designed case, soft handle for comfortable transport
- PC interface

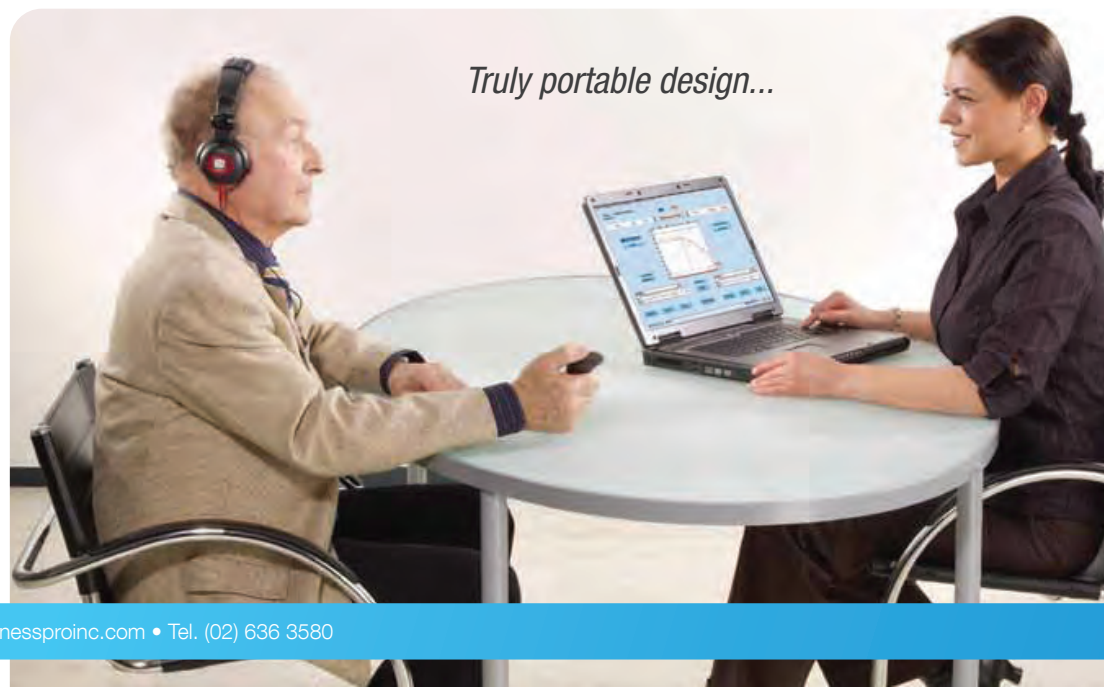

Truly portable design...

MEASURING INSTRUMENTS, TESTERS and SIMULATORS

GOSSEN METRAWATT

Safety through Competence

NUMBERG, GERMANY 

SECULIFE® | ST with (P)Si Module

Ensuring accuracy of your
Biomedical Equipment...



Premium class devices for medical technology

INSTRUMENTS OVERVIEW

SAFETY TESTERS



SECULIFE | ST



SECULIFE | SR



SECULIFE | SB

PATIENT SIMULATOR



SECULIFE | PS100



SECULIFE | PS200



SECULIFE | PS300



SECULIFE | NIBP

FUNCTION TESTERS



SECULIFE | DF+



SECULIFE | IF+

PHOTOMETRY



SECULIFE | IA



SECULIFE | IT



SECULIFE | IM



SECULIFE | IS

FUNCTION TESTERS, HF SURGERY



SECULIFE | ESBASE



SECULIFE | ESPRO



SECULIFE | ESXTRA

SOFTWARE

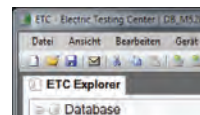

ETC Electric Testing Center



PerfectLum

CAP10

CAPNOGRAPH (Sidestream System)

The **CAP10** meets all the requirements demanded of a modern sidestream capnograph. The adjustable sampling rate and precise measurement cell allows the CAP10 to be used on all patients, from neonates to adults. The integrated rechargeable battery ensures continuous use and facilitates patient transport. A noise optimised pneumatic pump guarantees for long term use. The high capacity humidity filter ensures simple and hygienic application.

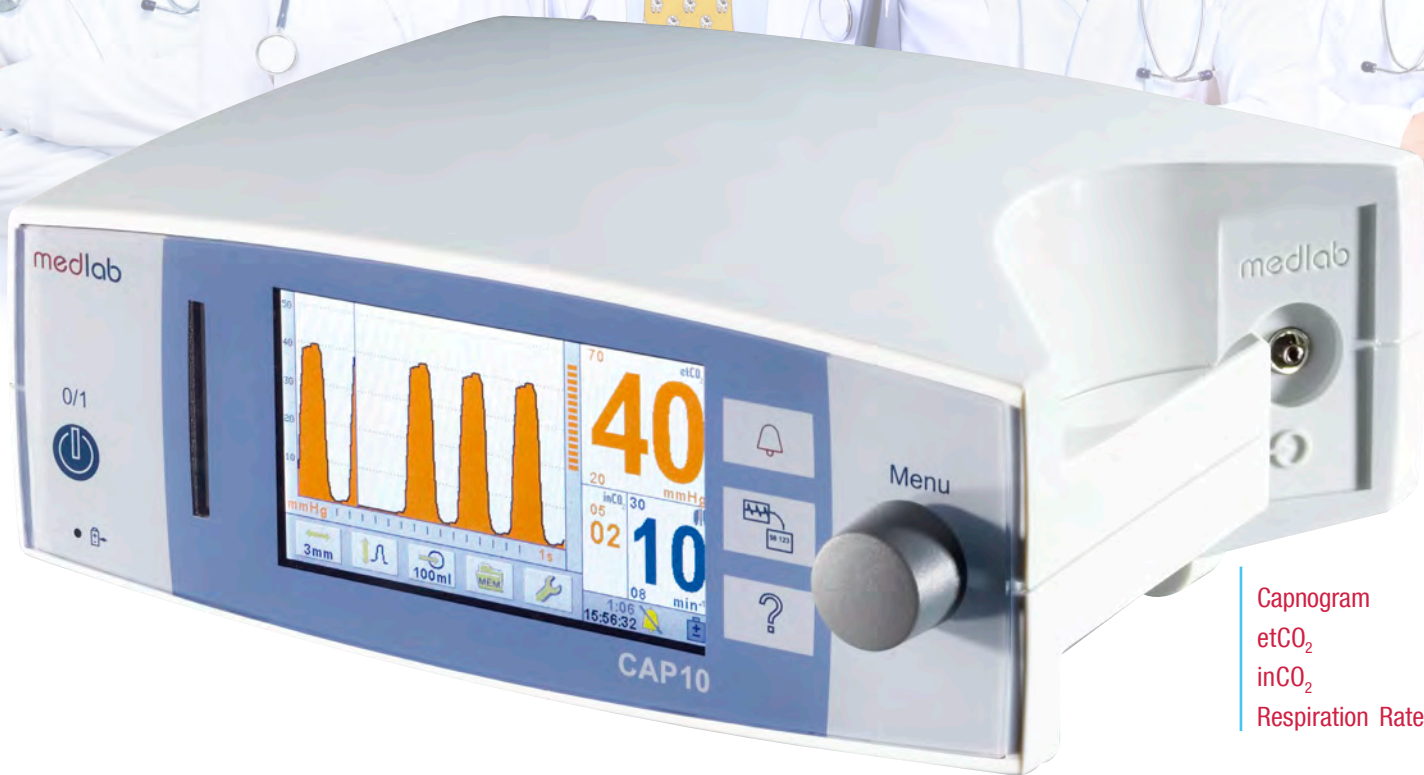

Capnogram
etCO₂
inCO₂
Respiration Rate

FEATURES

- Colour display (TFT) with high resolution
- Lightweight, compact and attractively designed
- Developed to be used with neonates, children and adults
- Display of etCO₂, respiration rate, and capnogram
- Trend display for etCO₂ and respiration rate
- Alarm system with audible and optical alarms
- NDIR sidestream technology, adjustable sample rate
- Serial data interface, optional analog outputs
- Works on mains and on integrated rechargeable battery

The new **CAP10** Capnograph with sidestream technology fulfills all requirements you have in clinical and pre-clinical applications for monitoring a patient's breath and CO₂ status. The bright, high resolution coloured TFT display shows the etCO₂ value, the inCO₂ value, the respiration rate and the capnogram. The sample rate is adjustable between 60 and 150 ml/min, to allow usage on adults as well as on neonates.

APPLICATIONS

- Anesthesia Monitoring
- Functional Diagnostics
- Verification of Intubation

PEARL10 TFT

PEARL10C TFT

Digital Artefact Suppressing Pulse Oximeter with TFT Screen and Charger Stand (Option)

SpO₂
Pulse

The **PEARL10** Pulse Oximeter features a bright, crisp TFT display. Despite of the high quality of this screen, the device works for more than 50 hours on one set of batteries. It is the first handheld unit that works with Medlab's new PEARL® technology. "PEARL" stands for "Pulse Enhancement Artefact Rejection Logic", a method for amplifying pulses and suppressing artefacts. With its new digital signal processing technology, the device works reliably in difficult situations, for example, on low perfused patients and during heavy patient movement. The PEARL10 features practically unlimited memory capabilities, since common MiniSD cards can be used for data storage. These cards can be directly used on any PC later. It is also possible to statistically evaluate the stored data directly on the large TFT screen. The standard display can be set to three different modes: large numerical, numerical - waveform and numerical - trend. A version with charger and built-in rechargeable battery pack is available (**PEARL10C**).

FEATURES

- Reliable measurement of SpO₂ and pulse rate
- Efficient artefact suppression
- Works reliably on low-perfused patients
- High quality and brilliant contrast TFT screen
- Can be used on adults, infants and neonates
- Trend and waveform display on TFT screen
- Integrated statistical analysis of the stored data
- Adjustable alarm limits, visible and audible alarms
- Saturation dependent pulse tone with adjustable volume
- Unlimited storage on standard MiniSD card
- Infrared interface for thermal printer
- Also available with charger stand (PEARL10C)

APPLICATIONS

- Sleep apnea screening
- Monitoring of patients showing low perfusion
- Measurement during patient movement



VITRO

VITAL SIGN MONITOR

The **VITRO** uses the advanced PEARL* pulse oximetry and a NIBP technology that works well from neonates to adults. The device can therefore be used in even the most demanding environments. The VITRO features an extremely well readable, and crisp colour TFT screen. The very reasonable price also makes the VITRO the ideal choice for ambulances and physician's practices, including patient monitoring in day surgery. The VITRO works with mains supply as well as with an integrated internal battery (approx. 4 h). The device shows systolic, mean, and diastolic pressure, SpO₂ values, pulse rate and the plethysmographic waveform of the patient.

Systolic Pressure
Diastolic Pressure
MAP
SpO₂
Pulse



FEATURES

- Crisp, easily readable TFT colour display
- Integrated context sensitive help system
- Plethysmogram, blood pressure, pulse, SpO₂
- Integrated 100 h trend display
- Automatical (cycled) or manual blood pressure measurement
- Adjustable alarm limits for all parameters
- Visible and audible alarms
- Saturation dependent pulse tone with adjustable volume
- IR Interface for thermal printer and PC
- Housing with integrated power supply, battery and carrying handle

By usage of this advanced pulse oximetry and an NIBP technology that works fine from neonates to adults, the **VITRO** can be used in even the most demanding environments. This includes neonatal and intensive care departments in hospitals.

APPLICATIONS

- Anesthesia Monitoring
- Blood Pressure Control
- Affordable Hemodiagnostic Monitoring

Neptune™ Touchless

Hand Hygiene Compliance Assurance System (HHCAS)

Reliable & Hassle Free Touchless Innovation
(with breakthrough **OPHARDT** technology at its core) for Effective Infection Control



FEATURES

- Reliable / Responsive Infrared Sensing Technology
- Low power consumption
- Runs on 4 D cell batteries
- Hygienic Disposable Pump & Cartridge System
- Flexibility in dispensing foam, alco-gel, lotion, grit/heavy duty soap, spray -- 5 in 1
- Secure trick lock
- Available in Outright Purchase or Service Rental Arrangements
- Transparent Window for Easy Content Level Indication
- Battery Indicator
- Easy Calibration of Dosage

COLOR VARIANTS



White



Black

**Standard units come with plain windows*

PUMP SELECTION

Clean Tip™
Technology



Foam



Liquid



Spray Pump



Quick and easy pump and bottle exchange



Optional counter tracks dispenser use

HARLOFF

COLORADO, USA 

EMERGENCY & CRITICAL CARE CARTS



6301

Short Four Drawer,
Specialty Package



Grab-and-Go Top Rail/Push Handle



Convenient Pull-Out Shelf



Rounded Corners



Stabilizing Pontoon Bumpers



Sturdy Breakaway Lock Bar

DESCRIPTION

Harloff tailors emergency carts to meet your needs. Harloff are well known for its custom capabilities. Whether it's changing carts to custom lock and drawer configurations, creating specialized accessories for unique facility requirements, or designing and building specially-sized carts.

FEATURES

- Breakaway locking system with 100 plastic numbered seals
- Unibody steel construction (also available in aluminum)
- Removable plastic top
- Top rail/push handle
- Ball-bearing full extension drawer slides
- Full wrap-around vinyl bumper on separate steel frame
- Five inch full swivel casters, one with brake, one directional
- Cart is delivered with wheels installed to reduce set-up time
- Powder coat finish – 17 colors available

HARLOFF Range



COLORADO, USA 



MS8160-VASC

MEDSTOR^{MAX}

Create a lean environment throughout your hospital with Harloff's Medical Storage line of carts and cabinets. These products are designed to strengthen your supply chain, increase work capacity and decrease operational costs. Harloff's Medical Storage line helps clinical departments put the right amount of supplies where they are needed while protecting them from pilferage or grazing, thereby reducing over-buying, hoarding, and expiration of unused supplies.



6025M-TC

Orthopedic Casting & Splinting Carts

Harloff's Orthopedic Casting-Splinting Supply Cart is designed for use in emergency departments, urgent care centers, ambulatory surgery centers and hospital based orthopedic surgery services.



AL810M7-ANS

Anesthesia Carts & Workstations

Harloff manufactures medical equipment used in surgical workplaces that promote improvements in operating room utilization and efficiency.



MRN6K-MAN

Magnetic Resonance Conditional Carts

Harloff's MR-Conditional Carts are built primarily of non-ferrous aluminum, plastic, and stainless steel for safe daily use in highly magnetic environments.

Now Harloff offers two cabinet sizes — Standard and Narrow Body. With packages for Anesthesia and Emergency requirements, multiple drawer configurations, and extra MR-Conditional accessories, Harloff is the right choice for storage, security and delivery needs in the Magnetic Resonance Imaging Suite.



V24-3K

Infection Control Carts & Stations

Help prevent the spread of infections within the healthcare setting by using Harloff infection control carts and cabinets. Lower hospital costs by reducing the number of hospital acquired infections.



6200

Treatment & Procedure Carts

Treatment carts are the perfect solution when you need to store topical ointments; eye, ear, nose and throat supplies; wound care supplies; and other bulkier nursing supplies, including surgical apparel, masks, dressing disposal bags, and blankets. These carts are seen throughout a hospital including hospital floors, nursing units, specialty clinics, operating rooms, and treatment rooms.



AL24CS-5

Medication Carts

Hospital pharmacies face complex clinical medication management issues on a daily basis. Harloff's goal is to help hospitals manage this complexity by offering a full line medication carts that will improve patient safety and reduce costs.



2720

Narcotics & Medicine Cabinets

Government rules and regulations require you to keep narcotics in secure locations. By storing drugs in narcotic cabinets, you can keep the potentially dangerous and addictive drugs out of the hands of individuals who may abuse them, while having them near at hand for the patients who would benefit from them. Harloff offers many different narcotic cabinets to help you keep both your controlled substances and your business secure.



WL480PC-CM

Wood-Look Carts & Cabinets

More and more hospitals want the warmer appearance of wood for storage of medical equipment and supplies. This shift from institutional looking medical carts and cabinets to a wood-look will help improve treatment outcomes for the patient and overall satisfaction for the family.

seca
HAMBURG, GERMANY 

Height and Circumference Measuring System



seca 216

Mechanical Measuring Rod for Children and Adults with Measuring Range Select Feature



seca 206

Microtoise / Mechanical Measuring Tape with Anti-Twisting Construction for longer lasting use

Easy to read height
Durable metal tape

seca 201



seca 203



Ergonomic Circumference Measuring Tape

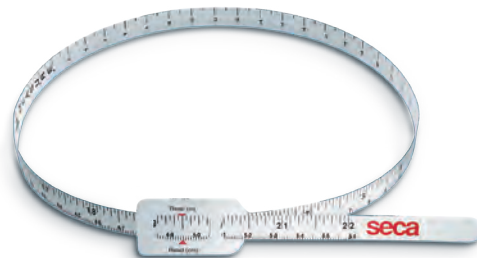

seca 212

Measuring Tape for Head Circumference of Babies and Toddlers

Precise and easy-to-read measurements



seca 213

Portable Stadiometer



Integrated handle for easy transport



Infant Oriented Scales



seca 374x

Digital Baby Scales with Large Tray, Wireless Connectivity and Measuring Rod



*Wireless Communication
Best for Hospital Nurseries & Pediatrician Clinics*

seca 727



Digital baby scale with fine 1 gram graduation and wireless transmission

Best for NICU



Double Use Electronic Baby Tray and Child Platform Scales

seca 354 Cap. 20kg



seca 383 Cap. 50kg



*Best for Clinics with Infants & Toddlers
Used & Deployed by UNICEF Worldwide*

seca 334x



Mobile Electronic Baby Scales with seca 232 Measuring Rod

Best for use across multiple sites

seca 725

Mechanical Baby Scales with Sliding Weights at 5g increment



seca
HAMBURG, GERMANY 

Mechanical Medical Column and Flat Scales

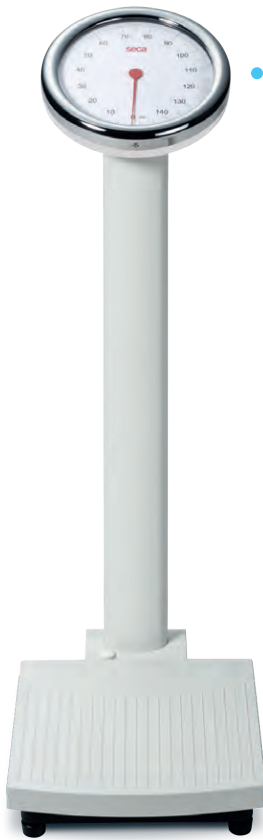

seca 786

Mechanical Column Scales with
Large Round Dial

Effortless weighing

*Determine Patient Weight As
Soon As He Steps On the Platform*

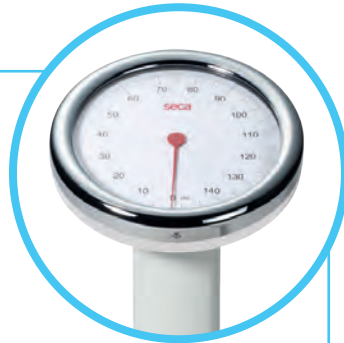

seca 700X

Mechanical Column Scale with
Eye Level Beam & Attached
Seca 224 Height Rod

*220 kg Capacity (50 g increment) /
60-200 cm range*

*Non Fading / Engraved Numbers Assuring
Always Easy-Read of Results*

*SECA Breakthrough Innovations on
the Familiar Beam Scale*

*The broad and flat construction provides
easy step-on access and a firm foothold*



seca 760

Robust Mechanical
Dial Floor Scale

*Powdercoated Casing of Colors
like Red, Yellow, Blue, etc.
(subject to availability)*

Certified accurate & precise

*150 kg Weighing capacity at
1 kg increments*

*Performs superbly in
a doctor's office to date*



Winner Medical Measuring Stations



HAMBURG, GERMANY

seca 284x



Innovative Wireless Measuring System For Height / Weight / BMI

Built in Frankfurt Line

HL 7 Compatible

300 kgs Weighing Capacity / 50 grams Increment

Measures Height of 30-220 cm at 1 mm graduation

Most suitable for Hospitals / Clinics / Diagnostic Centers

Included Options:

*seca 466 Wireless Printer,
seca 105 Analytics Software,
seca 456 Wireless USB*

For more info on seca 360° wireless visit:
<http://www.seca.com/english/us/home/innovations2010/360wireless/>

seca 466
for seca 360° wireless printer

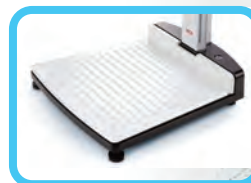

seca analytic software
for seca 360° wireless products



seca 763p



Electronic Weighing and Measuring Station with Integrated Printer

One step measurement process covering height / weight / BMI

Allows for TARE, auto-Hold, auto-BMI

PC RS232 connectivity via optional SECA 460 interface

Definitely for Heavy Patient Traffic Health Center Settings



seca 767x

Electronic Column Scale with Height Rod and BMI Function

Super Low Power Consumption - 6 pcs AA Batteries for 10,000 Weighings

Auto Shut Off

Precise at 100 g increments

Mother & Child Function

Perfect for Industrial Clinics, Medical Missions, Doctor's Office, Hospital Wards





Mobile Weighing and Measuring System

seca 250

Height and Length Measuring System
seca 217 Portable Stable Stadiometer & **seca 417** Infantometer

Components can be bought separately
Light, mobile, precise, robust

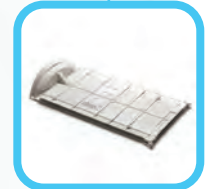

seca 217x

Portable Stable Stadiometer & Weighing Set Up with
seca 874 scale & **seca 437** adapter

Components can be bought separately
Used by UNICEF worldwide



Multifunctional Critical Weighing



seca 676

Electronic Wheelchair Scales
with Handrail & Transport Castors

Integrated ramp

Castors & Folding feature for easy transport

360 kg weighing capacity

*Precise weighing even with
handrail support (innovatively SECA)*



seca 664

Digital wheelchair / Platform Scales

Swiveling LCD with large letters for easy reading

*No side rails allowing for placement
in more (possibly tight) places*

360 kg capacity

Value for Money Digital wheelchair / platform scales





HAMBURG, GERMANY

Multifunctional Critical Weighing

seca 984

Electronic Bed & Dialysis Scale
with Equipment Trolley

*No more moving of patients.
No more cross infection issues.*

*Turn any & every hospital bed into
a weighing bed*

*1 Nurse alone can already use /
operate this*

500 kg Capacity

*Most appropriate for bed bound patients
where correct weighing is critical*



seca 952

Chair scale for weighing
while seated

*Foldable Arm & Foot Rests for Patient
Convenience*

200 kg Capacity

Bring the scale to the patient

Powder coated

Upright and Other Precise Measuring Instruments



*seca 417



Foldable, Stable, Light Mobile Measuring Board for Babies with 1mm increment

Used & Deployed by UNICEF Worldwide

seca 416

Infantometer for Babies (up to 24mo.) with locking system



Mobile, Rollable, Washable, Non-Fading Measuring Mat for Babies with 5mm increment

seca 210

seca 876



Mother and Child Function



Tip-on function for weighing without turning on the scale

*seca 874



Mobile Flat Scales with Easy Viewing Opposite Double Display & Tip On Function at 200kg Capacity

seca 856



Diaper Scale
Capacity: 5 kg

(* Included in seca 250 set)

Surgiris

taking care of you

FRANCE 

OR LIGHTS

"The Better LED Surgical Lights"

KALEA 30

 FOCUSMATIC



3500K



5000K

example of thyroid surgery : recurrent laryngeal nerve

DESCRIPTION

The KALEA® is an innovative LED surgical light manufactured by SURGIRIS based on a new optical lighting system Focusmatic™. Made of aluminium with modules of separate petals. Convenient for operating rooms with a laminar flow.

FEATURES

- Optical focal without any mechanical movement
- An automatic preventive maintenance
- Wireless communication technology
- Reliable performance
- Color temperature comfort
- Exceptional shadow dissolution
- Great constant depth
- Integration with laminar flow
- Patented Innovation
- Futuristic and innovative design

OR LIGHTS

"The Better LED Surgical Lights"

Surgiris
taking care of you

FRANCE 

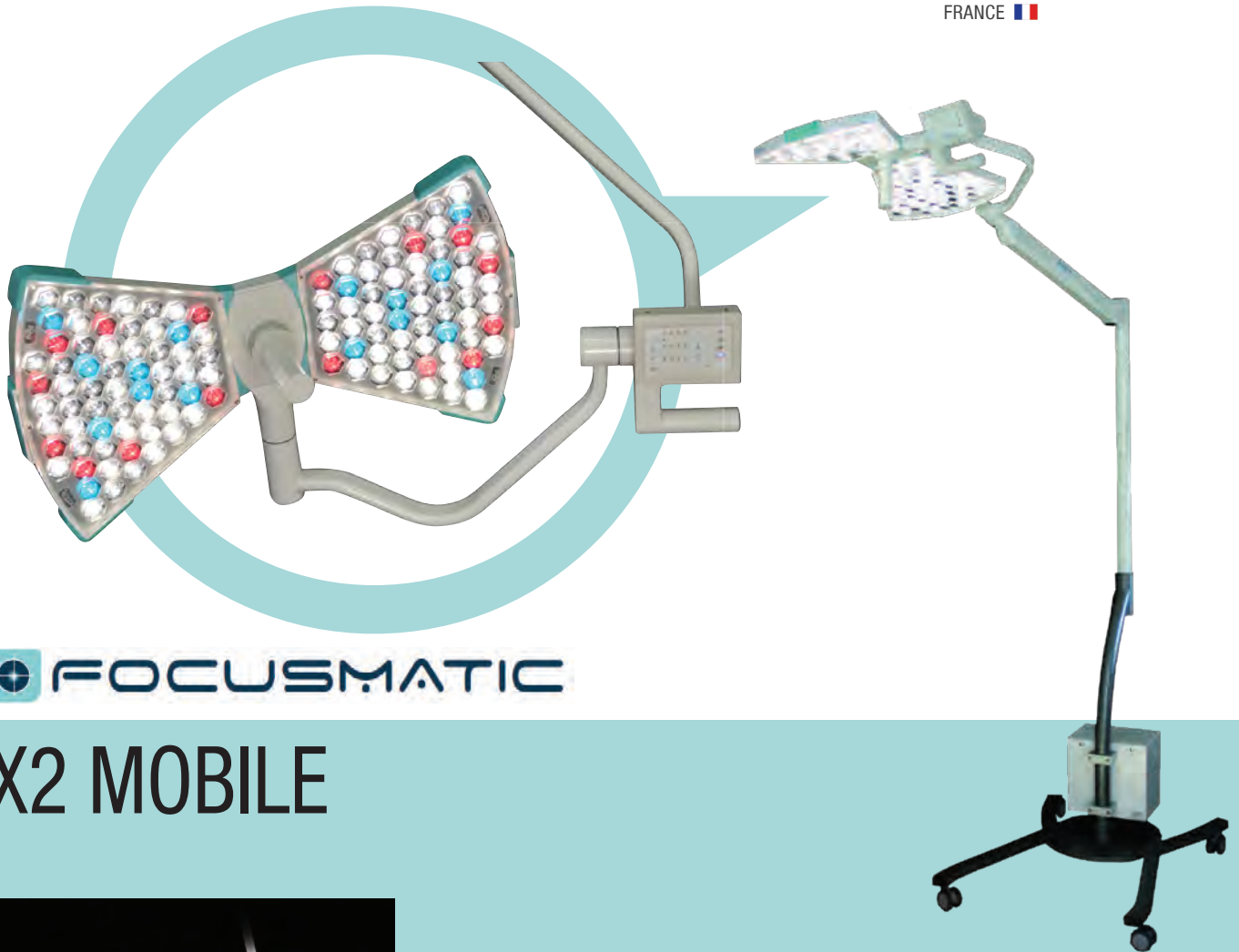

 FOCUSMATIC

X2 MOBILE



DESCRIPTION

Utilising efficient and advanced technology, the X2 offer new possibilities in several areas and meet the highest professional demands. Durability, adaptability and efficiency to individual operating room situations make this a light of choice. The X2 combine all the advantages of innovative LED technology with the most efficient energy management.

The X3 & X2 cupolas are innovative LED surgical lights manufactured by SURGIRIS based on a new optical lighting system Focusmatic™. Made of aluminium with module of separate petals, convenient for operating rooms with laminar flow systems. The X3 & X2 are available in MT (Multi-color Temperature) and ST (Single color Temperature) versions.

SINAPI biomedical

SOUTH AFRICA 

SINAPI CHEST DRAIN

"Better Medicine with New Breakthrough Chest Drain"

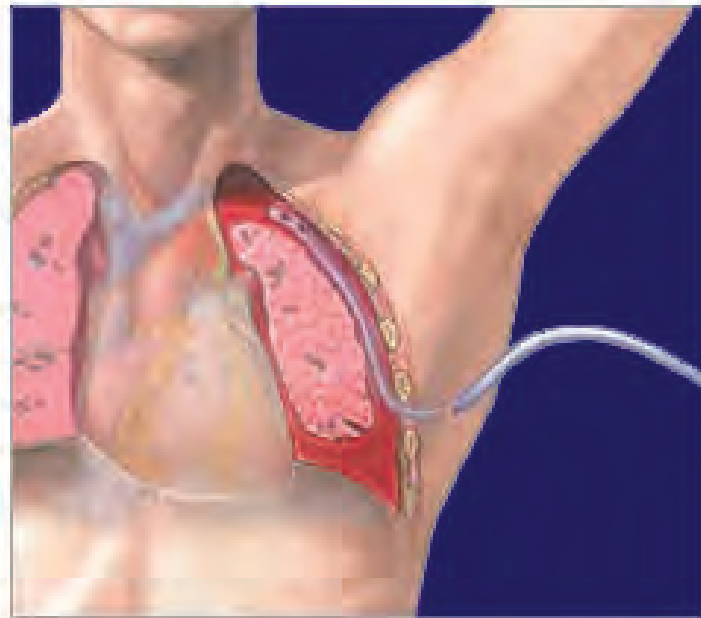

For the evacuation of fluids and air from the mediastinal and pleural cavities in post-operative or trauma settings



DESCRIPTION

The SINAPI Chest Drain is a drain chest drainage unit incorporating a dry seal, blood collection reservoir air leak detector, suction bulb and drainage tap.

FEATURES

- No Clamping
- Faster Evacuation
- Promotes early patient Mobility
- Superior Infection Control

BREAKTHROUGH : 1 WAY VALVE

Model: XL1000

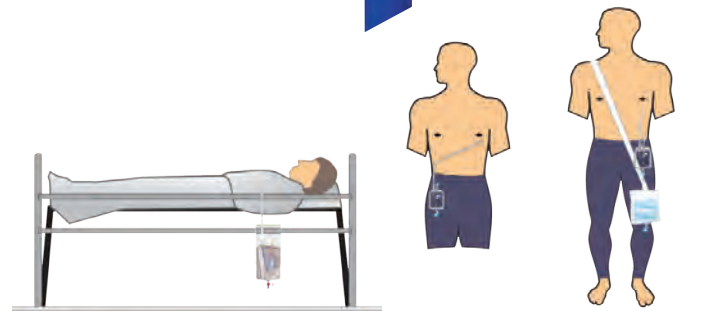

Gravity Drainage

Hemothorax

Pneumothorax

FM8000

MATERNAL FETAL MONITOR



Satisfaction Superiority Specialization

KOREA



Type FM8000G

FEATURES

- Light weight, easy operation
- 8.4" screen color LCD display, rotatable screen to 60°
- FHR 50-240 bpm
- Manual/Automatic records fetal movement
- Sound and color alarm for high and low fetal heart rate
- Continuous 24-hour real-time monitoring optional
- Continuous 12-hour patient curve and date storage, playback print
- With picture freeze function
- Single, Twins Monitoring optional
- Extra-long life with built thermal recorder



Type FM8010

FEATURES

- Color TFT folding color LCD : 0.2" color TFT folding LCD
- 9 crystal pulse wave Doppler transducer
- 152mm wide paper (US/International standard)
- Built-in rechargeable battery
- Accurate fetal movement detection and accounting
- Central monitoring interface

OTHER PRODUCTS

ECG MONITOR



CARDIPIA 400
Type 406N/406R

- Compact and light weight
- 4-lead patient cable
- Clear and reliable ECG trace
- Built-in rechargeable battery



CARDIPIA 200
Type 201N/203N

- Compact and light weight
- 4-lead patient cable
- Clear and reliable ECG trace
- Built-in rechargeable battery



THERMOFOCUS®

NON-CONTACT THERMOMETER

FDA CPR No.: MDR-01449

NO TOUCH • NO MERCURY • EASY TO USE • GOOD FOR ALL AGES



Model: TF1500

FEATURES

- Thermophile Sensor
- Self Calibrating
- Easy to use
- No Probe Cover Needed
- Good for all ages
- Heavy Duty
- Made in Italy



The only thermometer in the world to PROJECT the temperature on the forehead or on surface.

VISIOFOCUS®
NON CONTACT
thermometer



Simply reveals the body temperature without touching your baby. Just as easy as it should be.

Temperature at first sight

FEATURES

- At distance thermometer: Infrared technology
- Non invasive, no need to wake-up your baby
- 5 colour display backlight
- Takes food, objects and liquids temperature, skin and ambient temperature (1 to 55°C / 33.8 to 131.0°F)
- 9 memory function
- MQCS (Quick Calibration System)
- Clinic and doctor recommended

Assured After Technical Sales Service from WellnessPRO Technical Group

Whenever you get a medical device solution from Wellness PRO, congratulations are in order. You have surely gotten the better, the innovative of devices. Correspondingly, we promise you assured after sales support as follows:



48 hours diagnosis once on hand



Parts availability for WellnessPRO products in 8 weeks for current models



Warranty on parts used during repair for 6 months



Available Service unit (select basis) - free / charged



On site diagnosis on select basis



Tracking system repair status



No Hassle Tech service coordination



Quick reaction time for adverse events



Reminder on next check up/repair/calibration/tune up/cleaning



3 Defined levels of repair turn around time



Updates and notes on proper use/supplies



Restoration
(as pre coordination with client)

Portfolio of Services:

- Medical Equipment/Device Servicing
- Device Diagnostics
- Machine Calibration
- Technical Repair
- Audit of installation sites
- Preventive Maintenance
- Online / telecon assistance
- Electrical safety testing
- Function testing - defibrillators, infusion pumps
- Cautery function testing
- Insulation resistance testing
- Video monitor display testing
- Biomed technician updates / training clinics
- Lighting Testing
- Equipment Rental



JAPAN



SPAIN



ISRAEL



FRANCE



DENMARK



Quality for life

ITALY



DENMARK



JAPAN



USA



UNITED KINGDOM



mobility solutions

TAIWAN



GERMANY



USA



JAPAN



GERMANY



GERMANY



GERMANY



GERMANY



SWITZERLAND



Precision for health

GERMANY



GERMANY



SOUTH AFRICA



FRANCE



ITALY



Satisfaction Superiority Specialization

SOUTH KOREA

WellnessPRO

tomorrow's medical devices

Unit 1006 Richmond Plaza, San Miguel Avenue
cor. Lourdes Street, Ortigas, Pasig City 1605 Philippines

+63 2 6363580 • +63 2 6360930 • +63 2 6331931

+63 2 6367542

+63 9228232282 • +63 9209477185 • +63 9178513906

info@wellnessproinc.com

www.wellnessproinc.com

Established 2004